



OPERATING INSTRUCTIONS

Rev. 1.00

N-8000 SIP GATEWAY

Thank you for purchasing TOA's N-8000 SIP Gateway.
Please carefully follow the instructions in this manual to ensure long, trouble-free use of your equipment.

TOA Corporation

TABLE OF CONTENTS

Chapter 1 General Description

1. GENERAL DESCRIPTION	1-2
2. SYSTEM IMAGE	1-2
3. BASIC FUNCTIONS	1-2
4. SETTING STRUCTURE	1-3

Chapter 2 Functions

1. CONDITIONS OF SIP GATEWAY	2-2
2. SIP GATEWAY STRUCTURE	2-2
3. SIP GATEWAY FUNCTIONS	2-3
3.1. Details of functions	2-3
3.1.1. ㉔ Audio conversion	2-3
3.1.2. ㉕ Call from N-8000 to SIP	2-4
3.1.3. ㉖ Call from SIP to N-8000	2-5
3.1.4. ㉗ Paging function	2-6
3.1.5. ㉘ Control functions	2-6

Chapter 3 Settings

1. SETTINGS	3-2
1.1. Setting image for N-8000 side and SIP telephone side, and a main of SIP Gateway	3-2
1.2. ㉑ Setting of N-8000 system	3-2
1.3. Preparation for ㉒ and ㉓	3-3
1.4. Preparation for SIP Client setting	3-3
1.5. ㉔ SIP Client Setting	3-4
1.6. ㉕ SIP Gateway Setting	3-5
1.7. Setting example of N-8000 SIP Gateway	3-6

Chapter 4 Setting of SIP server

1. SETTING OF SIP SERVER	4-2
1.1. Setting for Asterisk	4-2
1.2. Setting for FreeSwitch	4-3
1.3. Setting of Cisco Call Manager	4-5
1.3.1. Registration procedure of SIP Client into Cisco SIP Server	4-5

Chapter 1

General Description

1. GENERAL DESCRIPTION

This manual is described for N-8000 SIP Gateway that has interconnecting functions between N-8000 and SIP system.

2. SYSTEM IMAGE

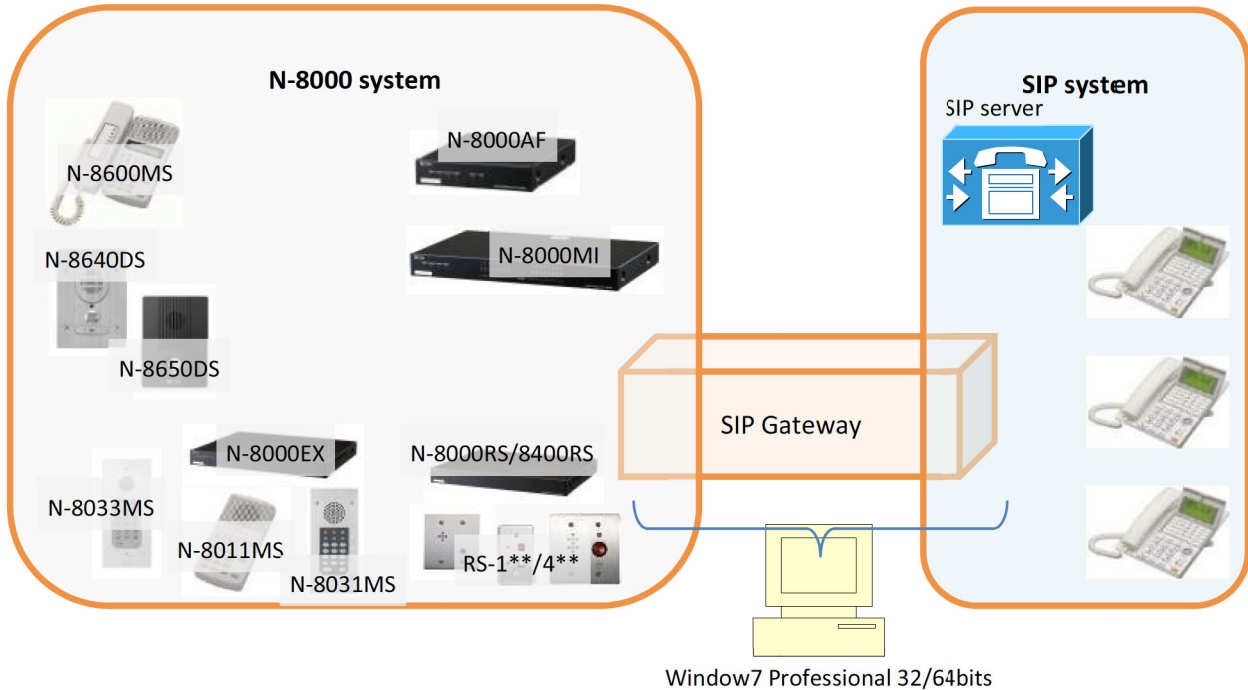

3. BASIC FUNCTIONS

N-8000 SIP Gateway has new functions by software working on Windows7 Professional 32/64bits, as below.

Function of N-8000 SIP Gateway	Description
Interconnection between SIP and N-8000 functions: (a), (b), (c), (d), and (e)	This software converts a call from N-8000 to SIP system and vice versa. One software has 5 speech paths at the same time. Transferring functions are also available from N-8000 to SIP system.
Paging from SIP to N-8000. functions: (f)	This software brings a “zone paging” and an “All-call paging” to the system. SIP telephone can make any paging. One server has 5 paging channels at the same time.
Contact control from SIP telephone functions: (g)	Dialing by a SIP telephone can control contact output of N-8640/50DS.

Note

(a)-(g) indicates functions' name which are explained in Section2.

4. SETTING STRUCTURE

There are 2 software settings to create a system, and another setting is needed for the other system which is SIP system.

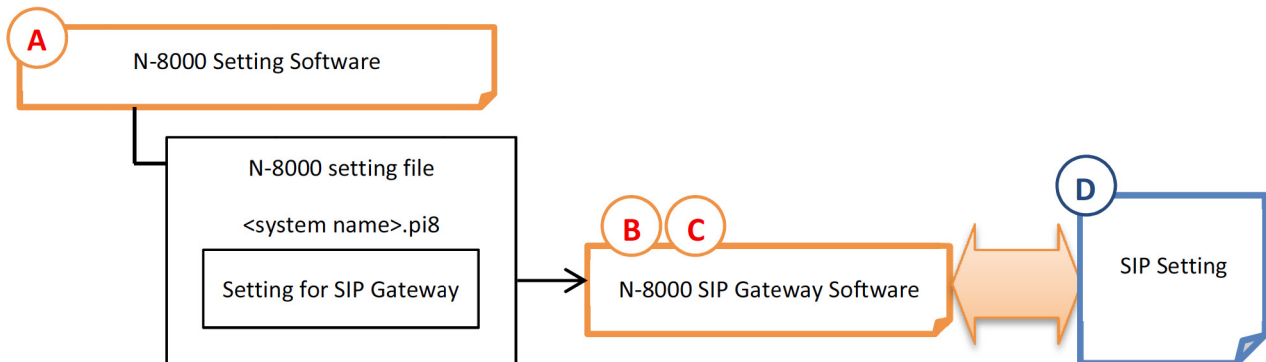

Note

Ⓐ-Ⓓ indicates settings which are explained in Section 3 and 4.

Chapter 2

Functions

1. CONDITIONS OF SIP GATEWAY

N-8000 SIP Gateway is tested with a SIP server of Cisco Systems, Asterisk, FreeSwitch, and Sipelia of Genetec Security Center.

2. SIP GATEWAY STRUCTURE

A SIP Gateway consists of 5 virtual master stations with one virtual N-8000EX, 5 virtual SIP clients, and audio processing functions.

There are 5 channels of speech paths between SIP telephone and N-8000. SIP Gateway has an audio processing function.

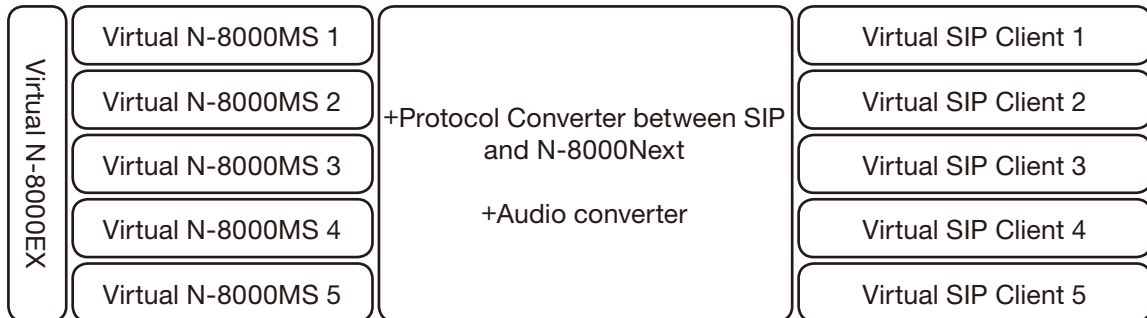

3. SIP GATEWAY FUNCTIONS

- (a) There is a function of converting from SIP protocol to N-8000 and vice versa.
- (b) There are 5 speech paths between SIP telephone system and N-8000.
- (c) SIP Gateway converts from SIP audio to N-8000 audio, and vice versa.
- (d) N-8000 station is connected to SIP telephone via N-8000 virtual station in a SIP Gateway.
- (e) SIP telephone is connected to N-8000 station via virtual SIP Client station in a SIP Gateway.
- (f) SIP telephone makes a station paging to N-8000 system with additional dials.
- (g) SIP telephone makes contact output control of N-8640/50DS as known “Door Remote Control” function.

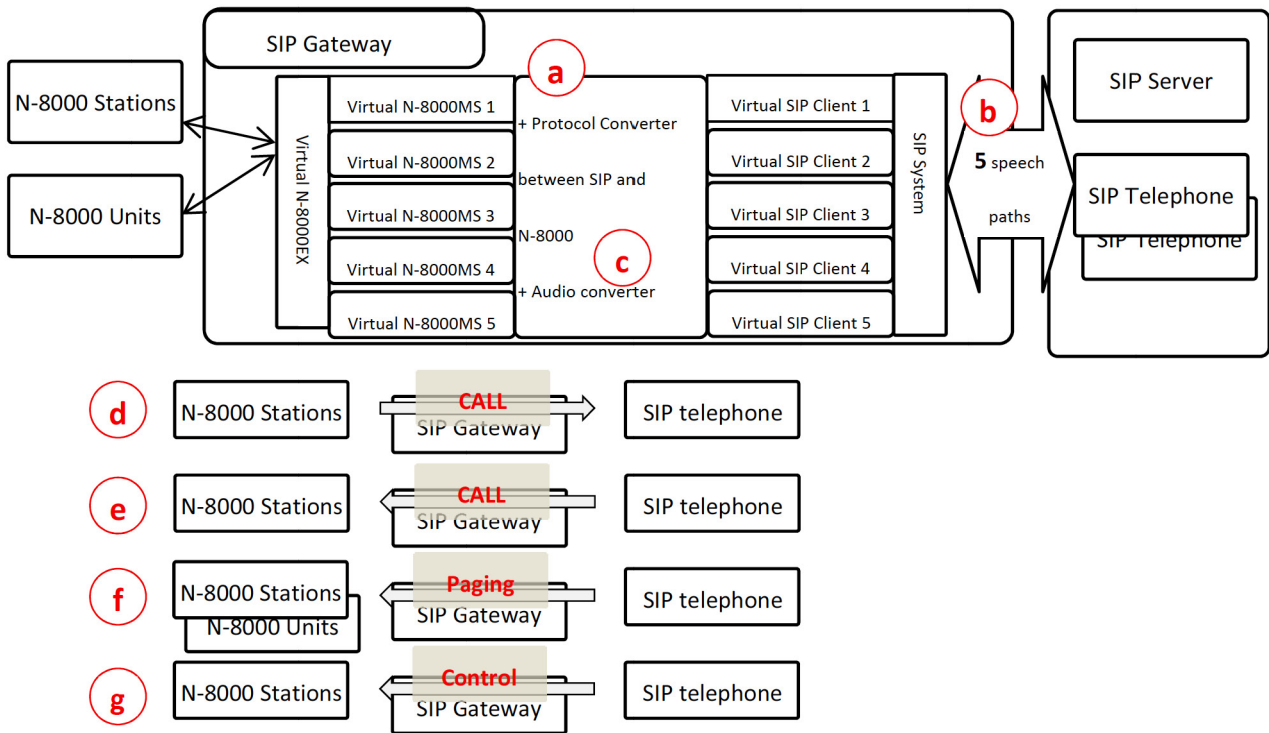

3.1. Details of functions

Functions of (a) and (b) are skipped.

3.1.1. (c) Audio conversion

A SIP Gateway converts audio from N-8000 to SIP telephone and vice versa. Both sides have a different sampling frequency and audio codec.

- N-8000 16 kHz, 8 kHz/ G.722
- SIP system 8 kHz/ G.711 u-law



3.1.2. ④ Call from N-8000 to SIP

By an example, its function is explained below.

[System example]

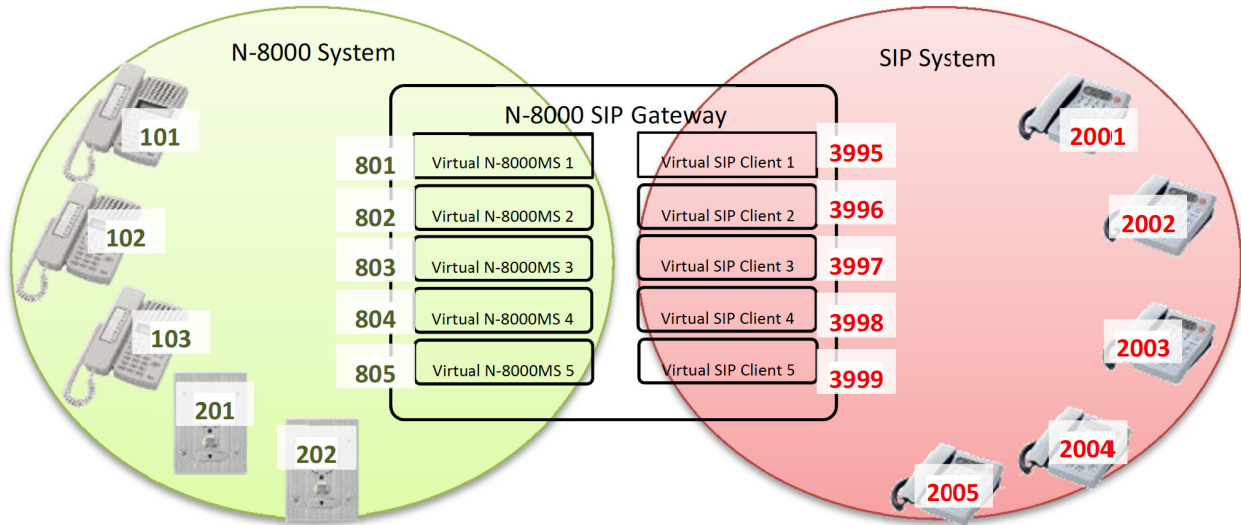

[Setting concept]

When N-8000 calls 801, virtual SIP client 1 has a setting to call to 2001.
 → Automatically transfer to 2001.

When N-8000MS(102) calls 805, virtual SIP client 5 has a setting to call to 2005,
 within a selected time (0 to 5 seconds), N-8600MS dials 2004, then talk.

[Operation]

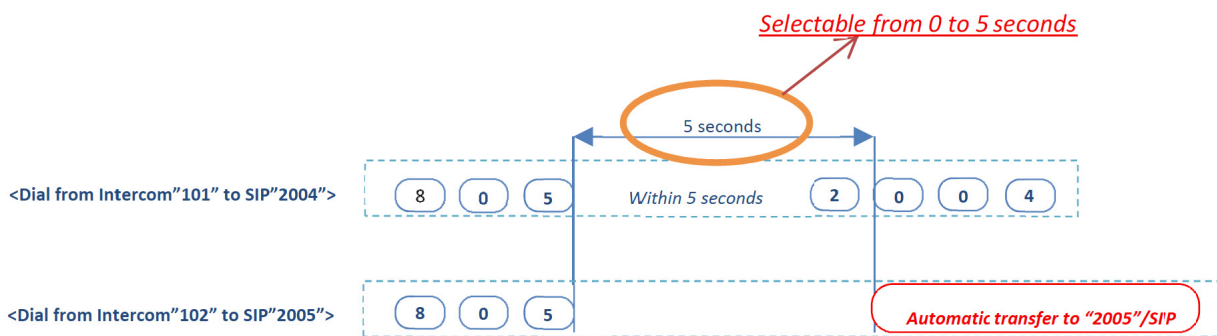

Tip

This "additional dial" function is only for N-8600MS with a special firmware. (The firmware is in a CD.)

3.1.3. ③ Call from SIP to N-8000

By an example, its function is explained below.

[System example]

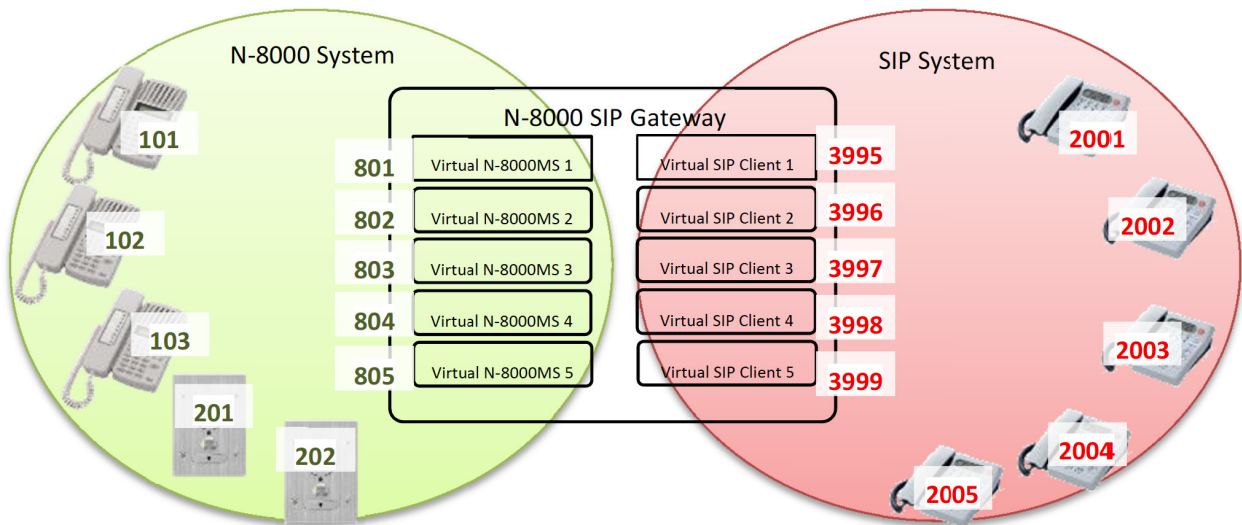

[Setting concept]

When SIP telephone calls 3995, virtual N-8000MS 1 has a setting of calling 101.

→ SIP telephone and N-8000 101 starts to talk.

When SIP telephone calls 3999, virtual N-8000MS 5 has a setting of calling 202,

Within a selected time (0 to 5 seconds), SIP telephone dials 103, then talk.

[Operation]

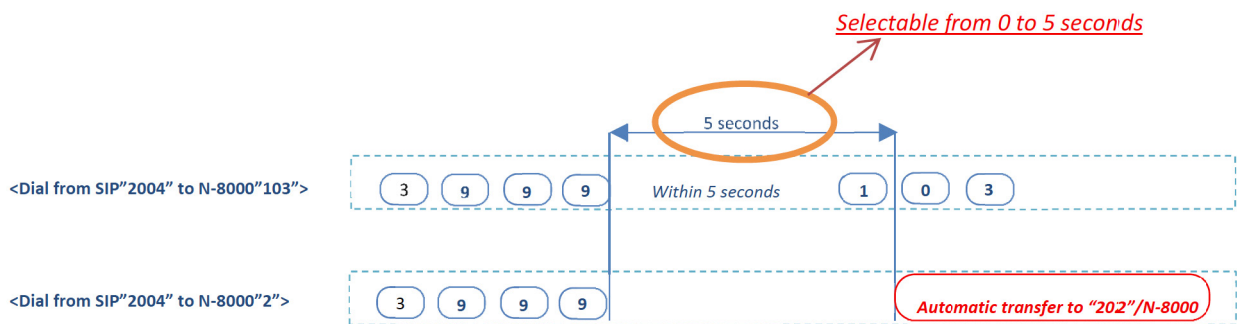

3.1.4. f) Paging function

Paging from SIP telephone to N-8000 system.

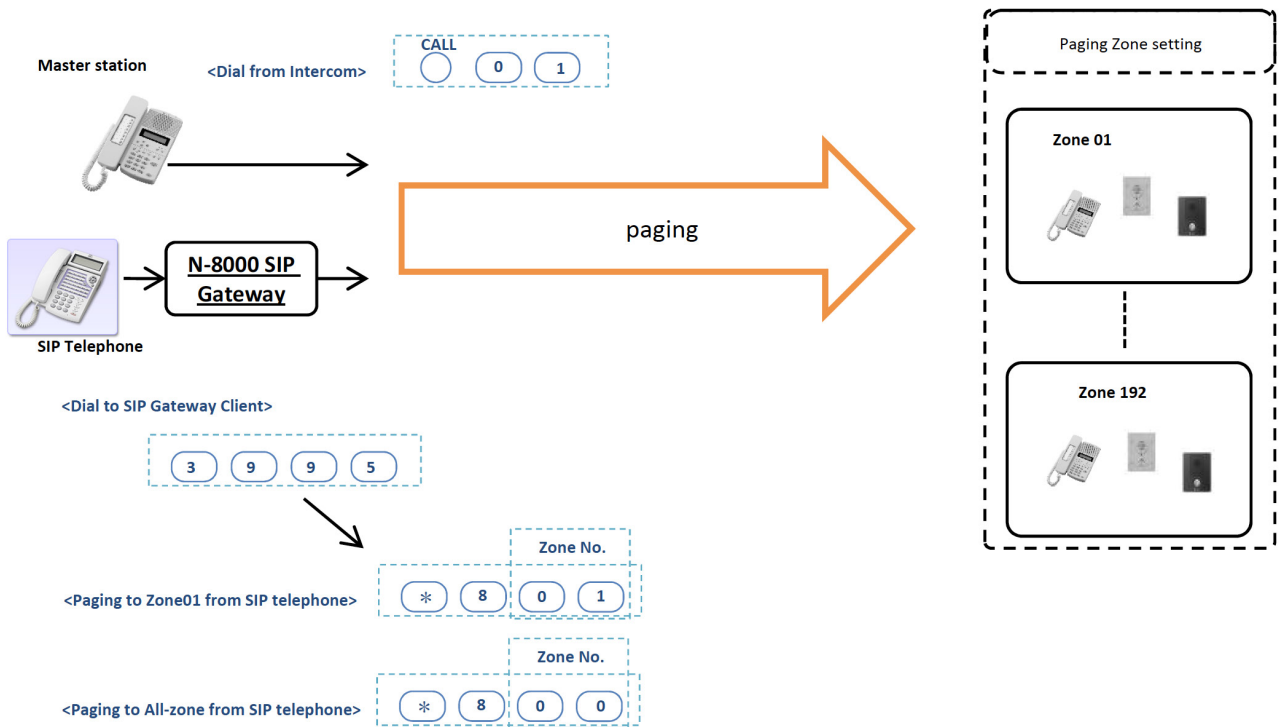

3.1.5. g) Control functions

Door remote control from SIP telephone for Door stations.

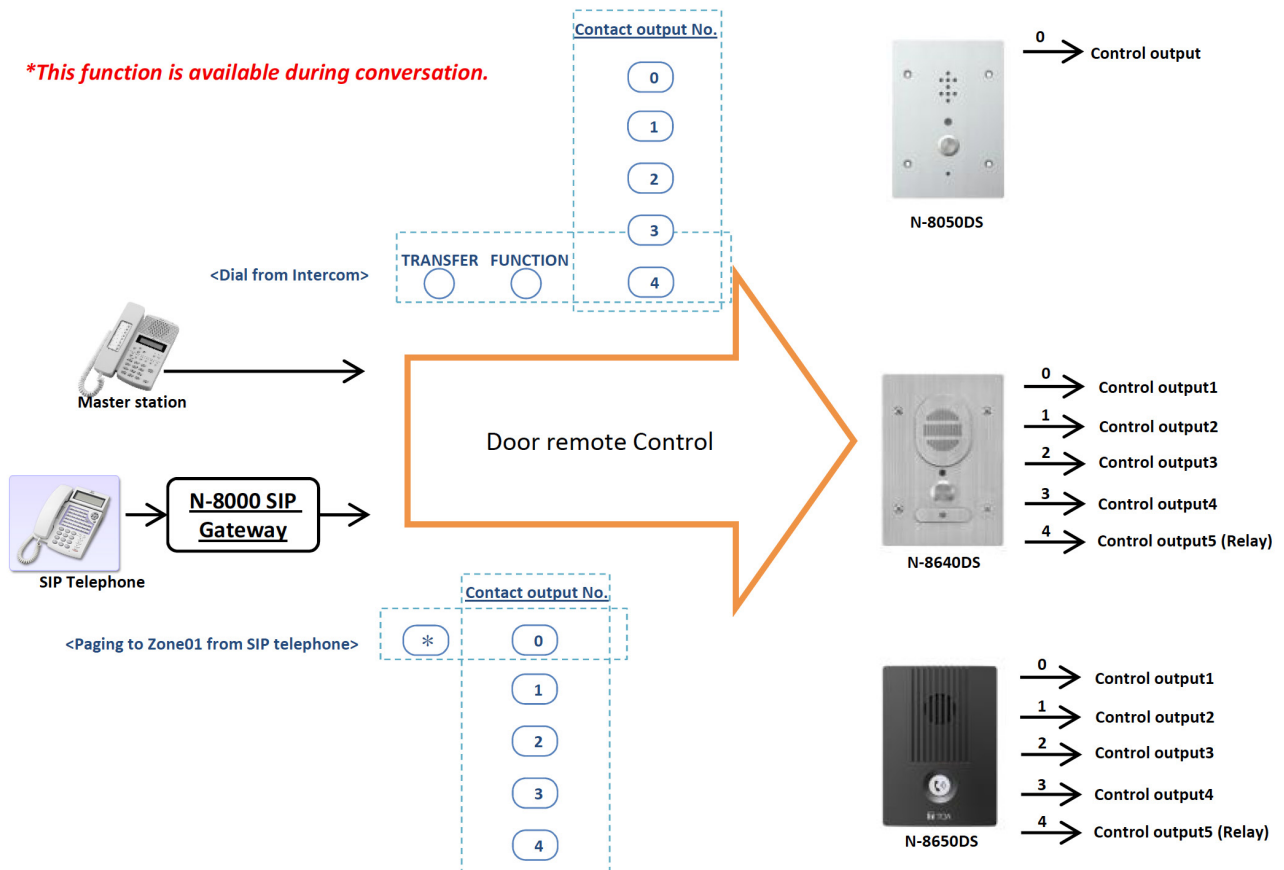

Chapter 3

Settings

1. SETTINGS

1.1. Setting image for N-8000 side and SIP telephone side, and a main of SIP Gateway

There are 3 steps of setting which are setting of N-8000 system, setting of SIP system, and setting of SIP gateway.

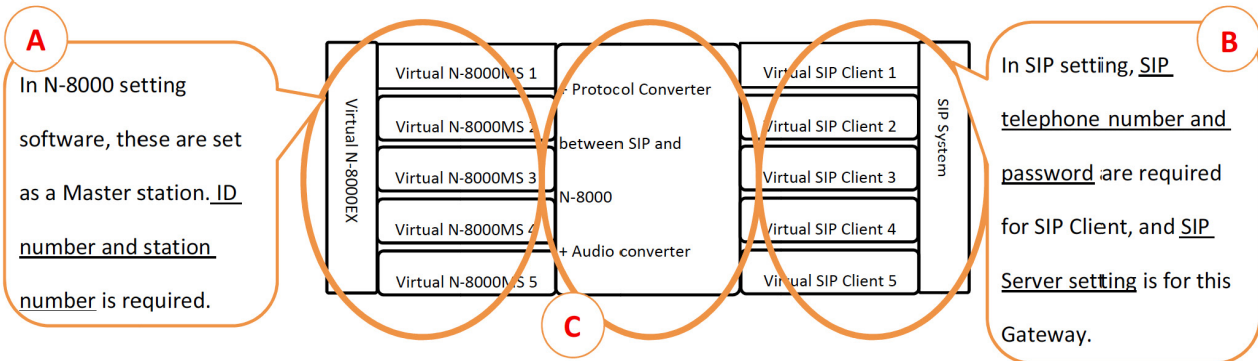

1.2. **A** Setting of N-8000 system

This N-8000 SIP Gateway is to be set as a N-8000EX and 5 N-8000MS, virtually. The following is an example of a setting for SIP Gateway.

Equipment Registration Table (Top Screenshot):

Equipment No.	Equipment name	Model	IP Address	Web Port	WAN IP Address	WAN Web Port
1	N-8600MS	N-8600MS	192.168.1.100	80		
2	N-8000EX	N-8000EX	192.168.1.11	80		
3	N-8600MS	N-8600MS	192.168.1.101	80		

Station Table (Bottom Screenshot):

Equipment No.	Equipment name	Line No.	Type	Station No.	Station name
1	N-8600MS	1	N-8600MS	102	N-8600MS
2	N-8000EX	1	N-8000MS	201	
		2	N-8000MS	202	
		3	N-8000MS	203	
		4	N-8000MS	204	
		5	N-8000MS	205	
3	N-8600MS	1	N-8600MS	101	N-8600MS

Annotations:

- Red Arrow 1:** Points to the IP address of the N-8000EX in the Equipment Registration table. Text: "This is for SIP Gateway. IP address is set for an IP address of PC which is installed N-8000 SIP Gateway."
- Red Arrow 2:** Points to the Line No. and Type columns in the Station Table. Text: "These are also for SIP Gateway. Station numbers for them are kinds of 'access code'. When N-8000 station wants to connect to SIP system, these station numbers can be dialed."

Note: This Equipment No. of virtual N-8000EX is used for the setting of SIP Gateway.

1.3. Preparation for (B) and (C)

The following is a window of SIP Gateway.

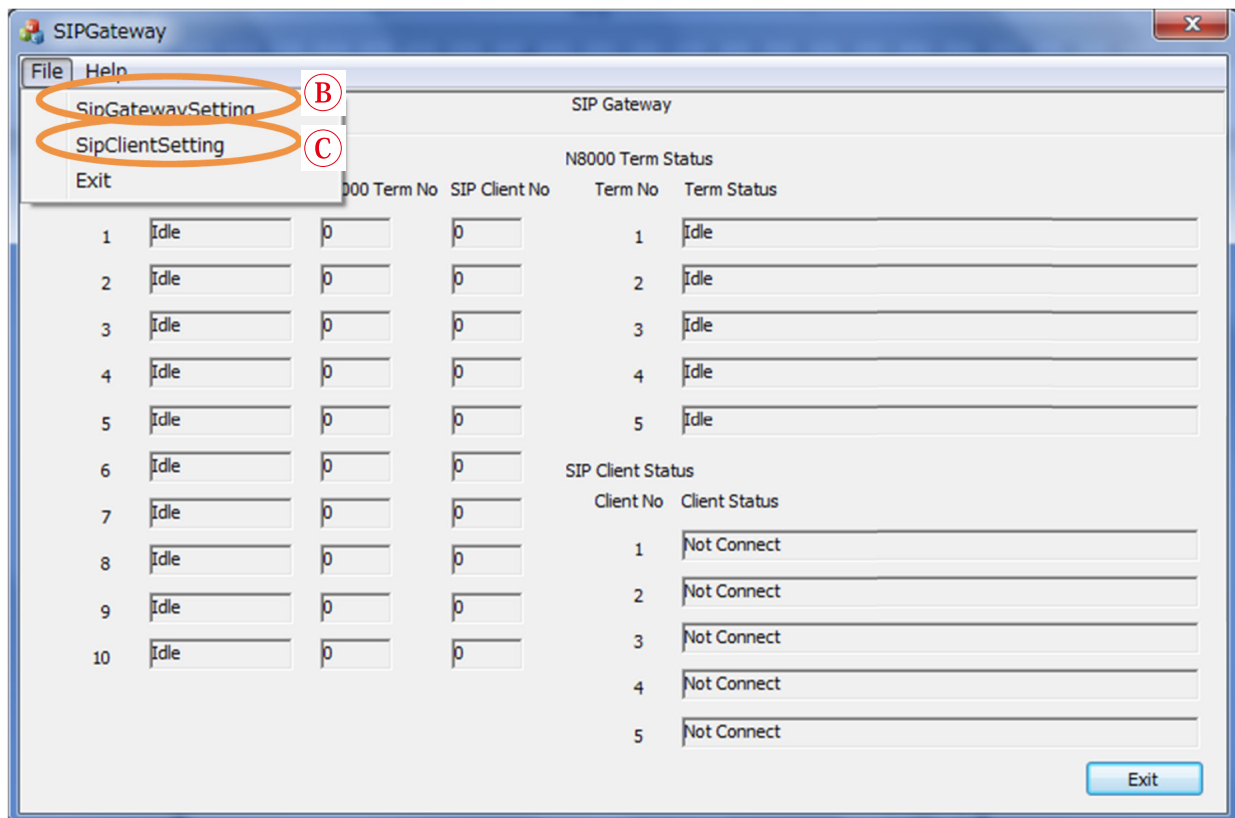

Settings are by a clicking File, there are menu of B: “SipClientSetting” and C: “SipGatewaySetting.”

1.4. Preparation for SIP Client setting

Connecting to SIP system, the following info. is needed.

No.	Item	Comment
1	IP address of SIP Server	–
2	SIP Port of SIP Server	Default is “5060”
3	Extension number for SIP Clients	SIP Gateway can have 5 SIP Clients
4	SIP device profile	Password requirement, and a method of Authentication can be set.

Registration command to a SIP server is executed right after starting this software up, and by every 140 seconds.

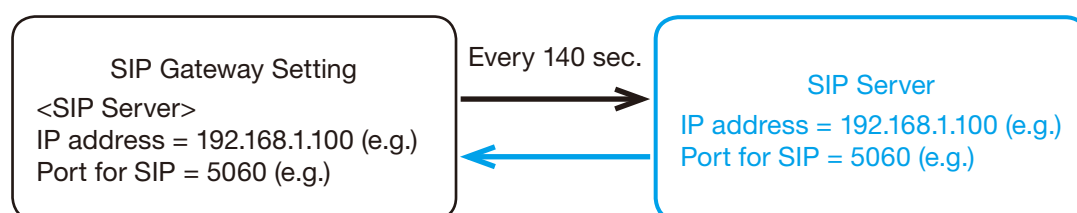

1.5. ① SIP Client Setting

Here is for all about SIP system.

Step 1. Setting for SIP Server. The port number with 5060 is a default of SIP protocol.

Step 2. SIP virtual Client telephone number which is registered to SIP server.

Step 3. A password for a SIP virtual Client for an authentication.

Step 4. Settings of IP address and RTP port for each virtual SIP client.

SIPClient Setting

SIP Server Setting

IP Address: 192 . 168 . 11 . 200

Port No: 5060

SIP Client Setting

No	Phone Number	Password	SIP Client IP Address	RTP Real Port No
1	201	••••••	192 . 168 . 11 . 102	4001
2	202	••••••	192 . 168 . 11 . 102	4002
3	203	••••••	192 . 168 . 11 . 102	4003
4	204	••••~•	192 . 168 . 11 . 102	4004
5	205	••••~•	192 . 168 . 11 . 102	4005

Save Cancel

1.6. © SIP Gateway Setting

Step 5. A location of N-8000 setting file which is <system name>.pi8 file.

Step 6. Waiting time for specific dialing from N-8000 or SIP telephone. After this time, SIP Gateway connects automatically to a certain station which is set in 4 for calling from N-8000, or in 5 for calling from SIP telephone.

Step 7. N-8000 equipment number, these should be matched to a setting of N-8000Next setting file selected in 1.

Step 8. Connecting N-8000 number which is called from SIP telephone side. Each virtual SIP Client has an individual target of N-8000 station.

Step 9. Connecting SIP telephone number which is called from N-8000 side. Each virtual N-8000 station has an individual target of SIP telephone.

SIPGateway Setting

N-8000 Setting File Name: C:\ProgramData\TOA\N-8000\... ⑤

N-8000 Term Setting **SIP Client Setting**

Dial Input Time Out Sec: 5 ⑥

No	Equipment No	Line No	Transfer Number
1	3 ⑦	1	101 ⑧
2	3	2	102
3	3	3	103
4	3	4	201
5	3	5	202

No	Transfer Number
1	2001 ⑨
2	2002
3	2003
4	2004
5	2005

1.7. Setting example of N-8000 SIP Gateway

The following is an example of a setting that N-8000's call to SIP.

[System example]

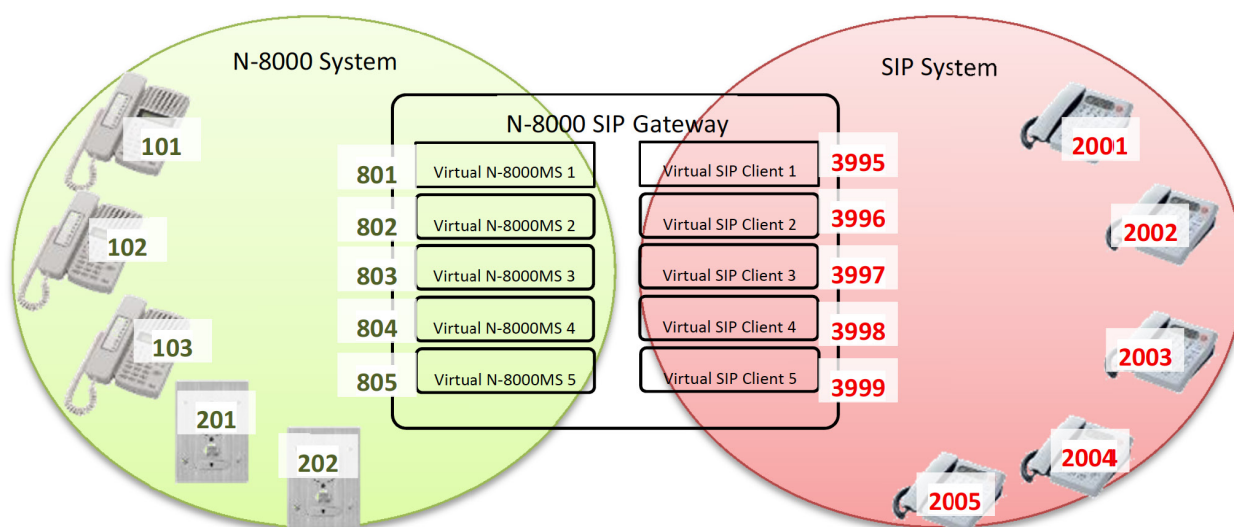

[Setting example]

When N-8000 side calls 801, N-8000 SIP Gateway connects to 2001 and 3 speech paths are prepared for this function, and when N-8000 side calls 804, N-8000 SIP Gateway connects to 2005 and 2 speech paths are prepared for this function.

N-8000 station	N-8000 setting content	Setting of N-8000 SIP Gateway
801	802 is for "Group-hunting"	virtual SIP client 1 has 2001 in SipGatewaySetting
802	803 is for "Group-hunting"	virtual SIP client 2 has 2001 in SipGatewaySetting
803		virtual SIP client 3 has 2001 in SipGatewaySetting
804	805 is for "Group-hunting"	virtual SIP client 4 has 2005 in SipGatewaySetting
805		virtual SIP client 5 has 2005 in SipGatewaySetting

When SIP telephone calls 3995, N-8000 SIP Gateway connects to 101 and 2 speech paths are prepared for this function, and when SIP telephone calls 3997, N-8000 SIP Gateway connects to 102 and 2 speech paths are prepared for this function, and when SIP telephone calls 3999, N-8000 SIP Gateway connects to 103.

SIP extension	SIP client setting content	Setting of N-8000 SIP Gateway
3995	3996 is for "Busy transfer"	virtual N-8000MS 1 has 101 in SipGatewaySetting
3996		virtual N-8000MS 2 has 101 in SipGatewaySetting
3997	3998 is for "Busy transfer"	virtual N-8000MS 3 has 102 in SipGatewaySetting
3998		virtual N-8000MS 4 has 102 in SipGatewaySetting
3999		virtual N-8000MS 5 has 103 in SipGatewaySetting

[Example of N-8000 Setting software, N-8000 SIP Gateway software]

In the N-8000 Setting software, N-8000 SIP Gateway is set as N-8000EX. IP address and port is for a PC that N-8000 SIP gateway software is installed.

Note: In the later step, equipment No. will be used.

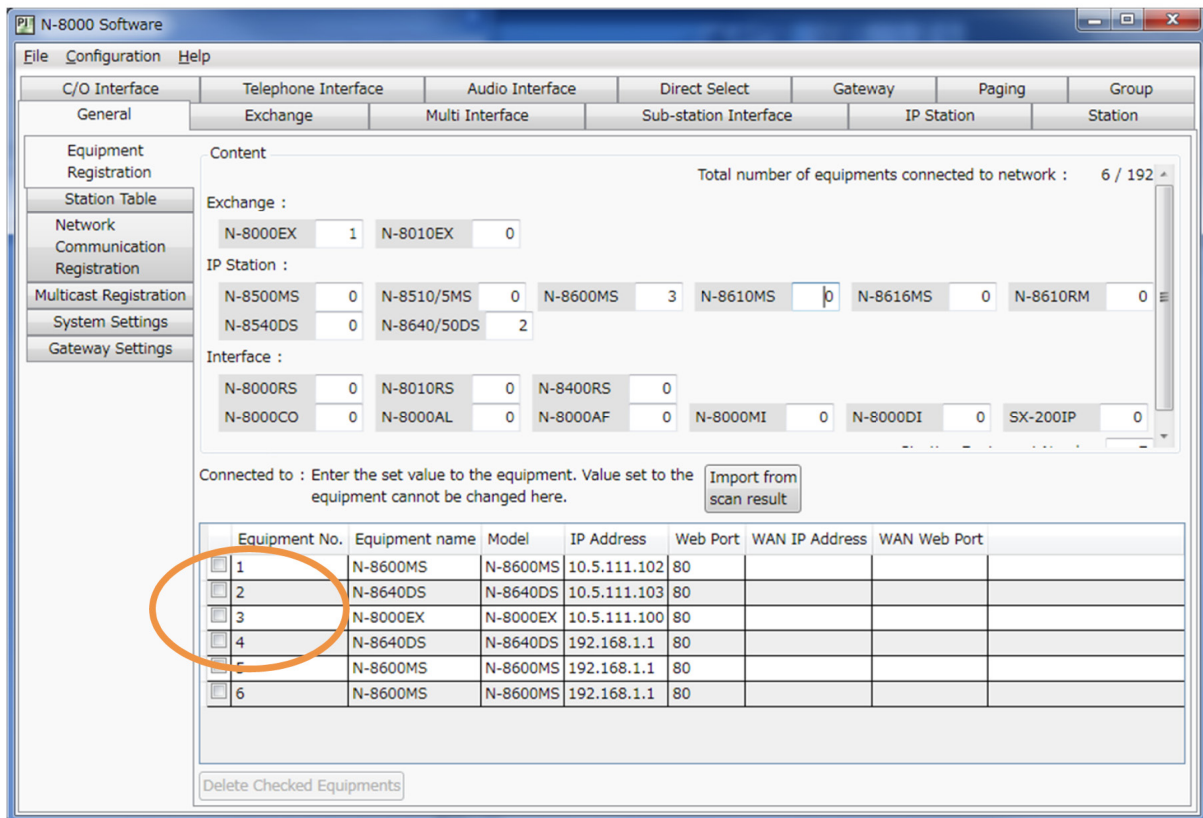

The next is setting for virtual N-8000MS. Line 1 to 5 are used for N-8000 SIP Gateway, 801 to 805 are set according to this example.

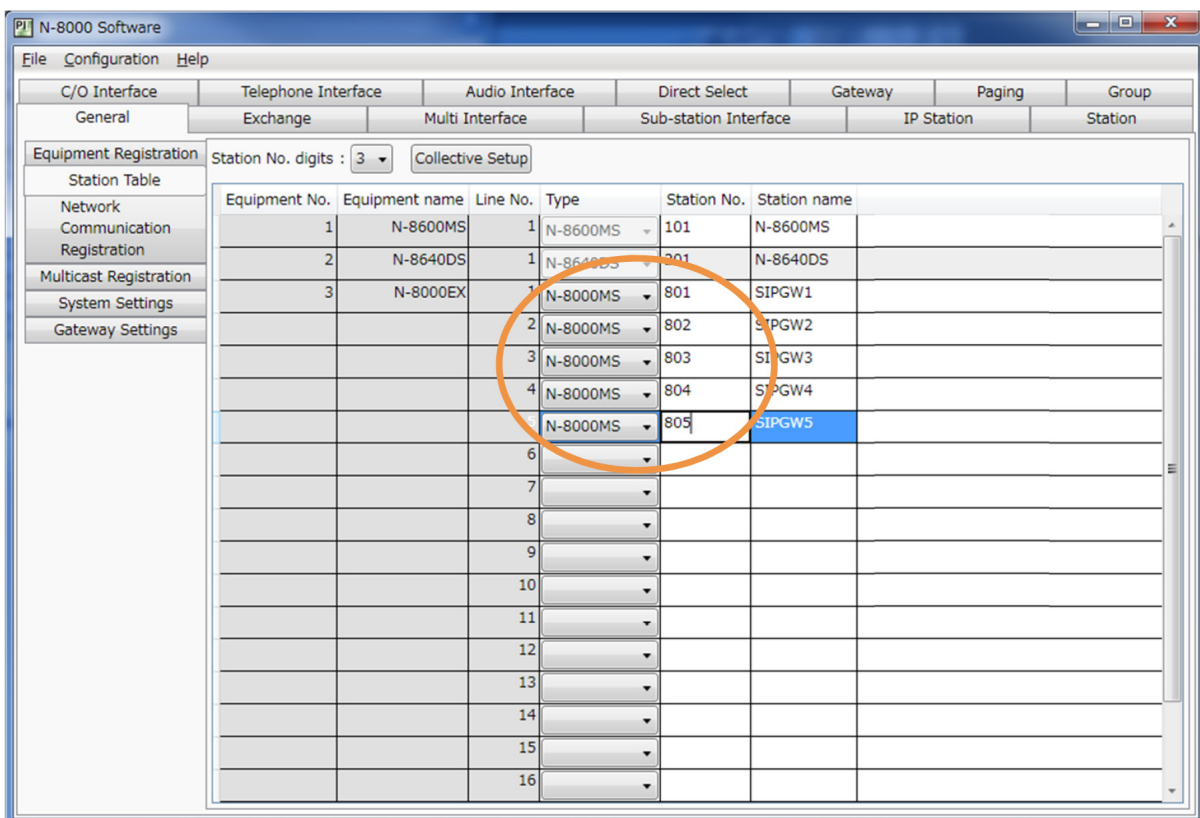

This is for the function that calling to 801 in the N-8000 system has 3 speech paths that goes to 2001 in SIP system.

The following example is a setting for 801 to add 802 in the box of “Group hunting to.” Additionally a setting for 802 is needed to transfer to 803. While 804 in the N-8000 system connecting to 2005 in SIP system needs 2 speech paths, then a setting for 804 needs to have 805 in the box of “Group hunting to.”

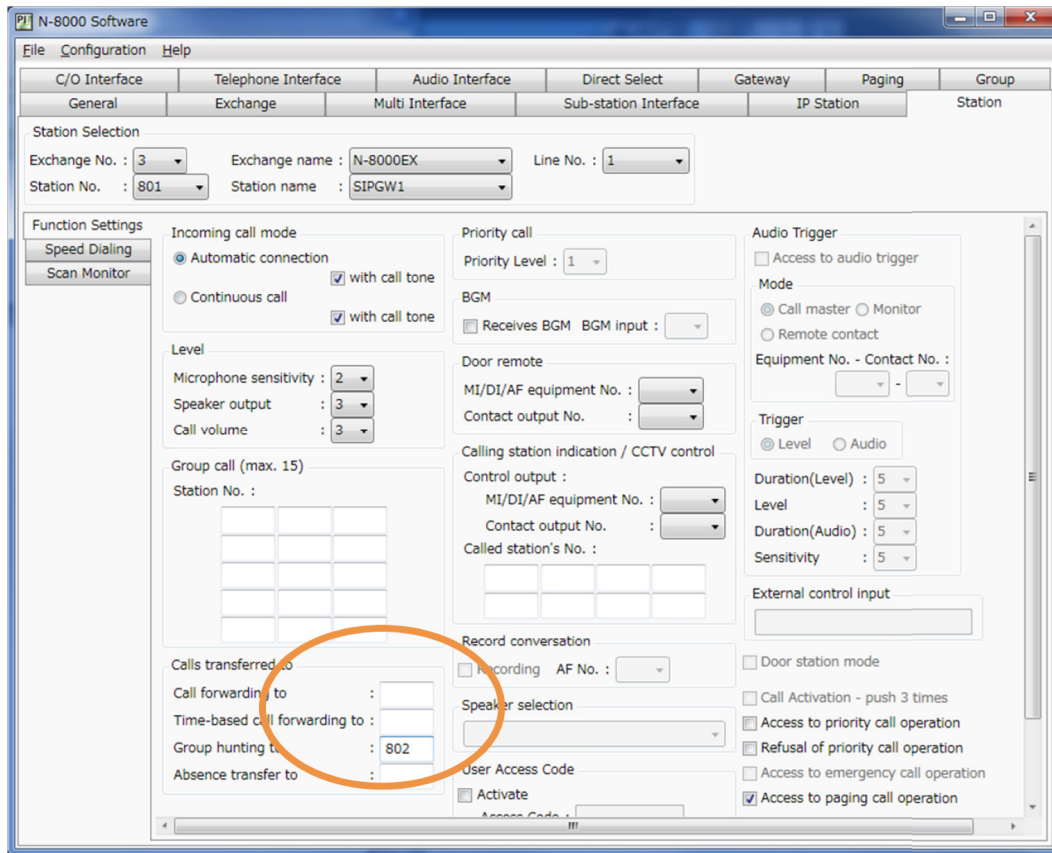

After all setting, a setting file shall be exported. As shown below.

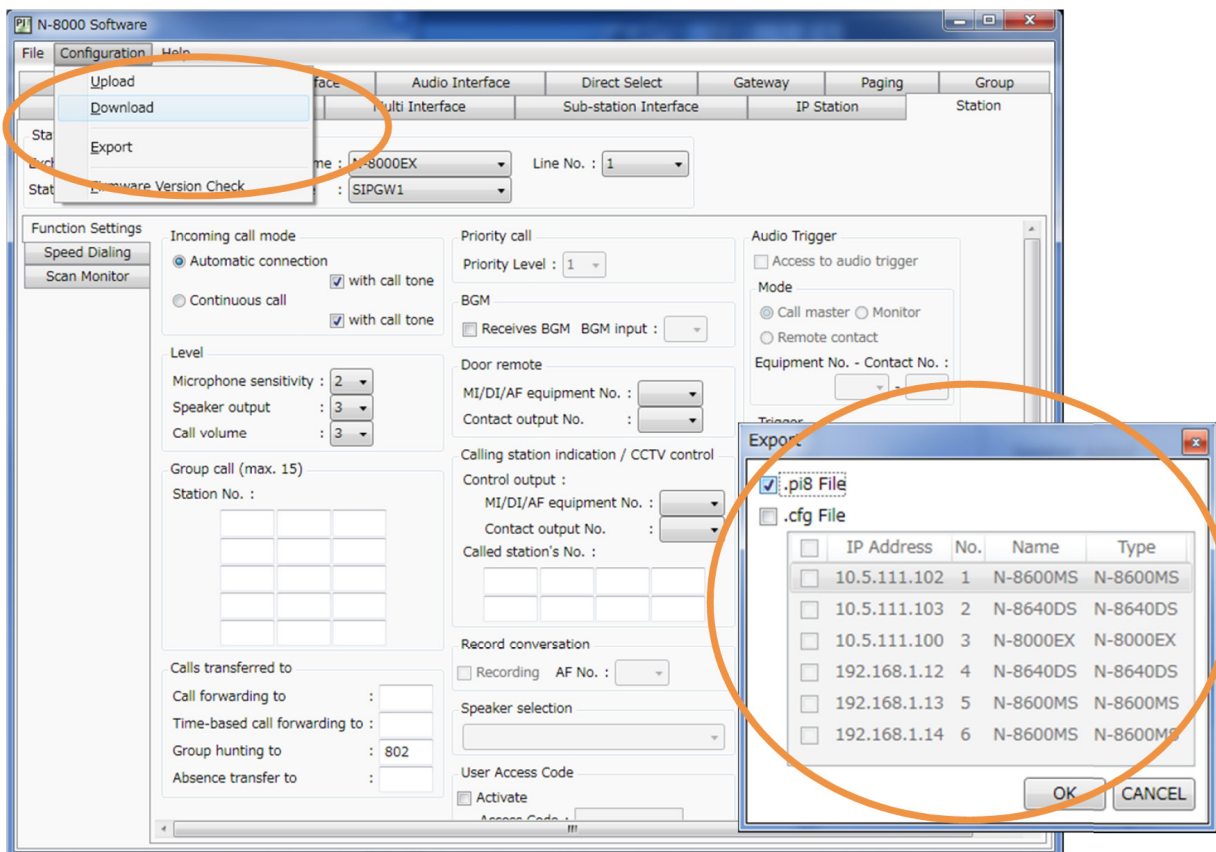

The next step is a setting of N-8000 SIP Gateway.

N-8000 SIP Gateway uses a N-8000 Setting file that is <system_name>.pi8. Then the equipment No. that is programmed in the N-8000 Setting software (in this example, it's 3). In the left with "Transfer Number" requires numbers that N-8000 SIP Gateway connects to N-8000 system side by a request from SIP system. The right box for "Transfer Number" is for SIP telephone number that N-8000 SIP Gateway connects by a request from N-8000 system.

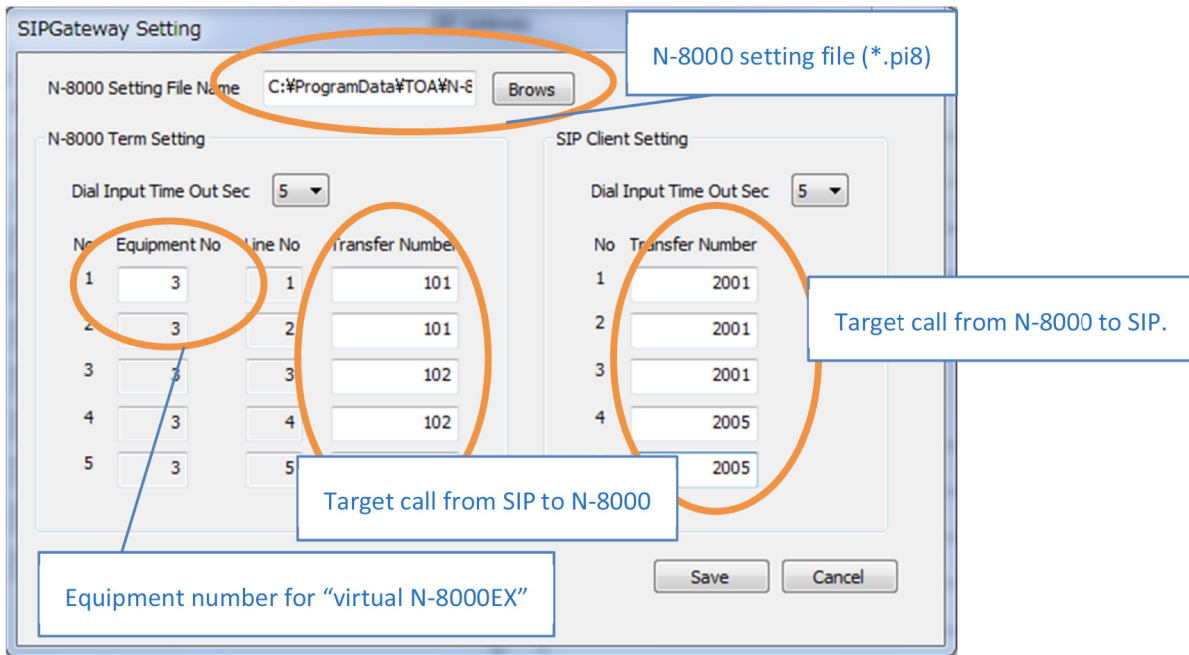

A setting of SIP server is also needed.

All SIP server has a different way for the setting, therefore the following is just basic setting contents.

- 5 SIP clients for N-8000 SIP Gateway shall be prepared. Extension numbers shall be 3995 to 3999 for this example.
- Passwords for each extension numbers are set.

Finally SIP server setting is needed for N-8000 SIP Gateway setting. That can be done by selecting from a menu of "File/SipClientSetting."

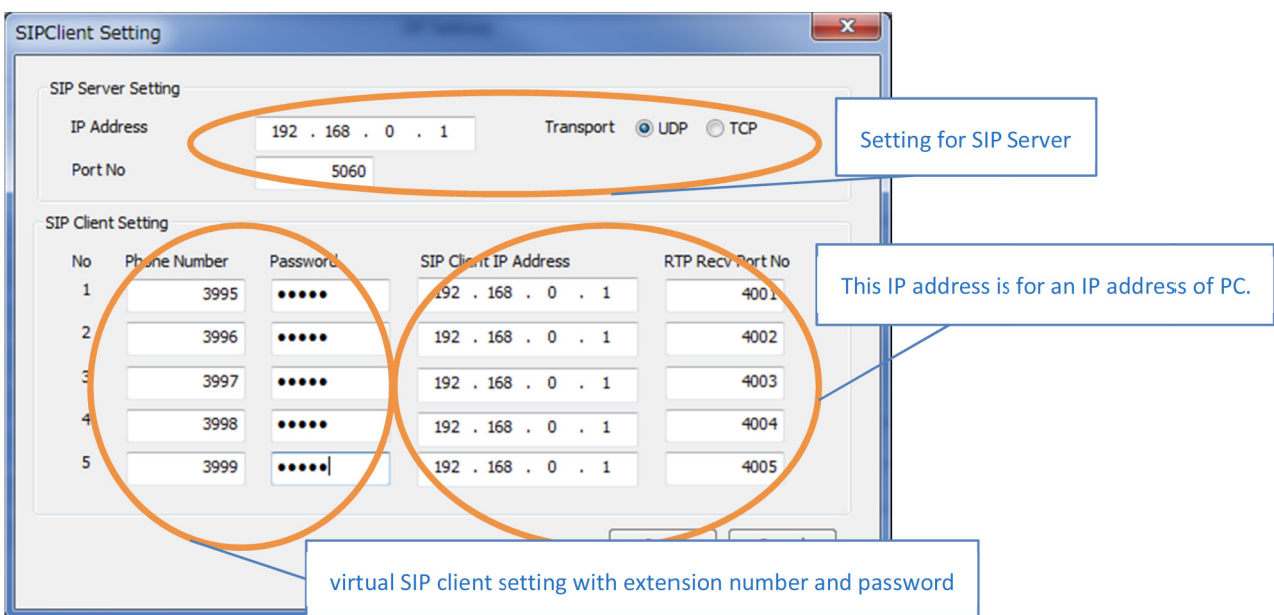

That's all.

Chapter 4

Setting of SIP server

1. SETTING OF SIP SERVER

What N-8000 SIP Gateway requires are as below;

- Extension number (telephone number) for SIP clients.
- Corresponding password for each extension number.

Additional setting like transferring function can be set by other settings.

1.1. Setting for Asterisk

Files for a basic setting are with sip.conf and extensions.conf.

Configuration idea with sip.conf (for Extension number and password)

```
[general]
context=default
port=5060
bindaddr=0.0.0.0
language=ja
musiconhold=default
disallow=all
allow=ulaw          * G.711/u-law setting must be set.
;allow=alaw
;allow=gsm
;allow=ilbc
dtmfmode=rfc2833   * RFC2833 must be set here for DTMF tone.
[3995]              * This is a setting for "3995" to be added.
type=friend
defaultuser=3995
secret=pass        * Here is for a password.
canreinvite=no
host=dynamic
dtmfmode=rfc2833   *RFC2833
[3996]              * This is a setting for "3996" to be added.
type=friend
defaultuser=3996
secret=pass        * Here is for a password.
canreinvite=no
host=dynamic
dtmfmode=rfc2833   *RFC2833
:
```

Configuration idea with extensions.conf (for a setting of process of SIP Server)

[default] section as below will be modified

```
exten => 3995,1,Dial(SIP/3995,12)    *3995 means a station number that is set in sip.conf file.
exten => 3995,2,Congestion
exten => 3995,102,Busy
exten => 3996,1,Dial(SIP/3996,12)    *3996 means a station number that is set in sip.conf file.
exten => 3996,2,Congestion
exten => 3996,102,Busy
exten => 3997,1,Dial(SIP/3997,12)    *3997 means a station number that is set in sip.conf file.
exten => 3997,2,Congestion
exten => 3997,102,Busy
:

exten => _,1,Answer()
exten => _,2,Wait(2)
exten => _,3,Playback(pbx-invalid)
exten => _,3,Congestion
```

1.2. Setting for FreeSwitch

Files for a basic setting are with directory/default/****(Extension number).xml and dialplan/default.xml. Configuration idea with (Extension number).xml (Extension number and password can be set in this file.)

Step 1. New user setting file is added.

That file like 3995.xml can be created by copying 1000.xml. The file is for one user.

Step 2. The new setting file is modified from a file made in the step 1.

e.x.) 1000.xml is copied and created 3995.xml to 3999.xml.

Modification idea for 3995.xml

```
<include>
  <user id="3995">
    <params>
      <param name="password" value="${default_password}"/>
      <param name="vm-password" value="3995"/>
    </params>
    <variables>
      <variable name="toll_allow" value="domestic,international,local"/>
      <variable name="accountcode" value="3995"/>
      <variable name="user_context" value="default"/>
      <variable name="effective_caller_id_name" value="Extension 3995"/>
      <variable name="effective_caller_id_number" value="3995"/>
      <variable name="outbound_caller_id_name" value="${outbound_caller_name}"/>
      <variable name="outbound_caller_id_number" value="${outbound_caller_id}"/>
      <variable name="callgroup" value="techsupport"/>
    </variables>
  </user>
</include>
```

Item	Content
user_id	Extension number
vm-password	Voicemail password
accountcode	Authenticated extension number
effective_caller_id_name	User name notified to the corresponding client
effective_caller_id_number	Number notified to the corresponding client

Configuration idea for dialplan/default.xml (5 clients for N-8000 SIP Gateway is added, and busy transferring function is added.)

e.x.)

```
<extension name="N8000SIP1_Extension">      * For User1 (3995)
<condition field="destination_number" expression="^(3995)$">
<action application="export" data="dialed_extension=$1"/>
<action application="set" data="hangup_after_bridge=true"/>
<action application="set" data="continue_on_fail=true"/>
<action application="bridge" data="user/${dialed_extension}@${domain_name}"/>
<action application="answer"/>
<action application="transfer" data="3996"/>      * 3996 is a station number transferred from 3995
<action application="sleep" data="1000"/>
<action application="bridge" data="loopback/app=voicemail:default ${domain_name} ${dialed_extension}"/>
</condition>
</extension>
<extension name="N8000SIP2_Extension">      * For User2 (3996)
<condition field="destination_number" expression="^(3996)$">
:
:
:
```

Action	Data	Content
	extension_name	Unique name for a dial plan.
	destination_number	User ID for a setting target. Multi-user ID can be set.
set	hangup_after_bridge	Whether the next dial plan is processed or not in case of "hung-up bridge status." true: Stop the current process. false or no definition: Continue the current process.
set	continue_on_fail	Whether the next dial plan is processed or not in case of busy or off-line status on the receiving station. true or error-code: Continue the current process. false: Stop the current process.
bridge	user/\${dialed_extension}@\${domain_name}	Receiving process.
answer		Answer to a call from others or session from others.
transfer	From 3996 to 3999	In case that this client/user is occupied by any reasons, a client/user in this section is transferred from this client/user.
sleep	1000	This is a time of lasting dial plan's process.
bridge	loopback/app=voicemail:default	In case of no call, the caller who made a call to this client/user will receive a voicemail.

1.3. Setting of Cisco Call Manager

1.3.1. Registration procedure of SIP Client into Cisco SIP Server

Step 1. Create a new profile with Digest Authentication for Telephone Security *only the beginning.

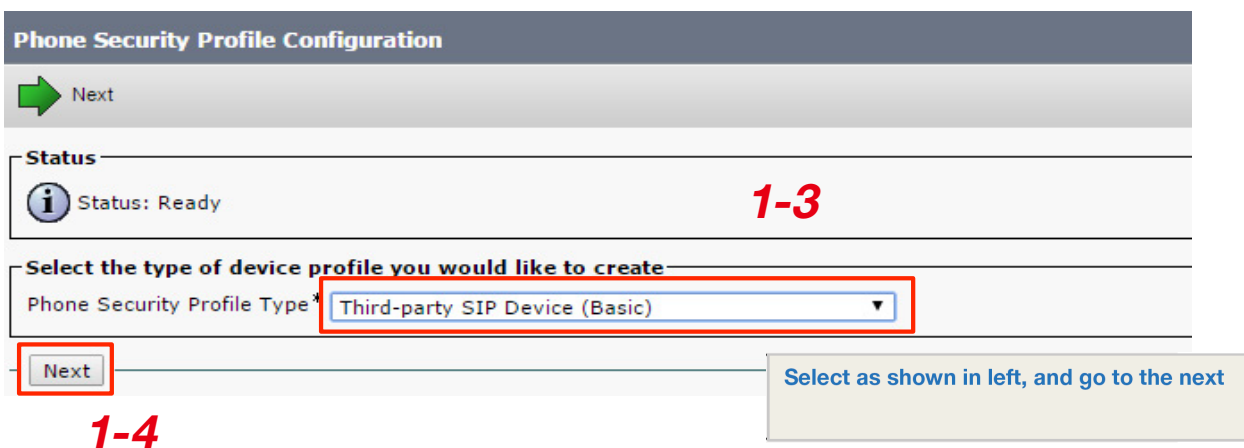
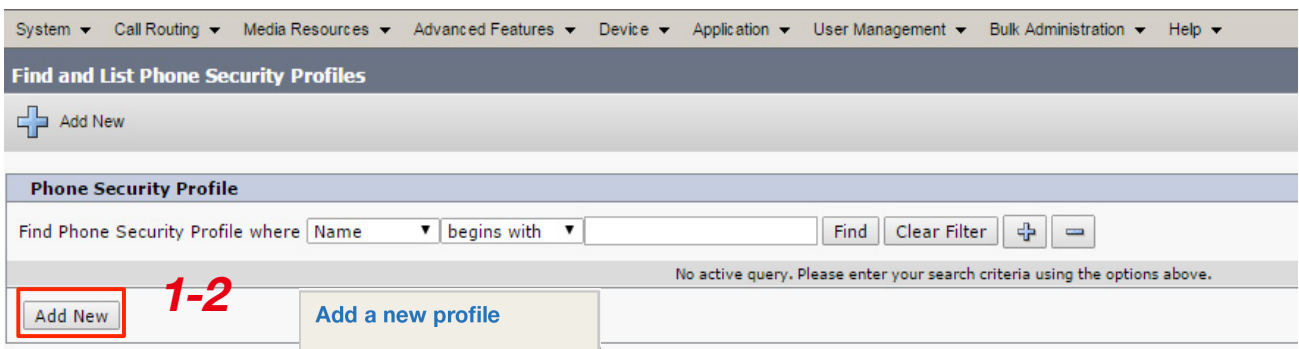
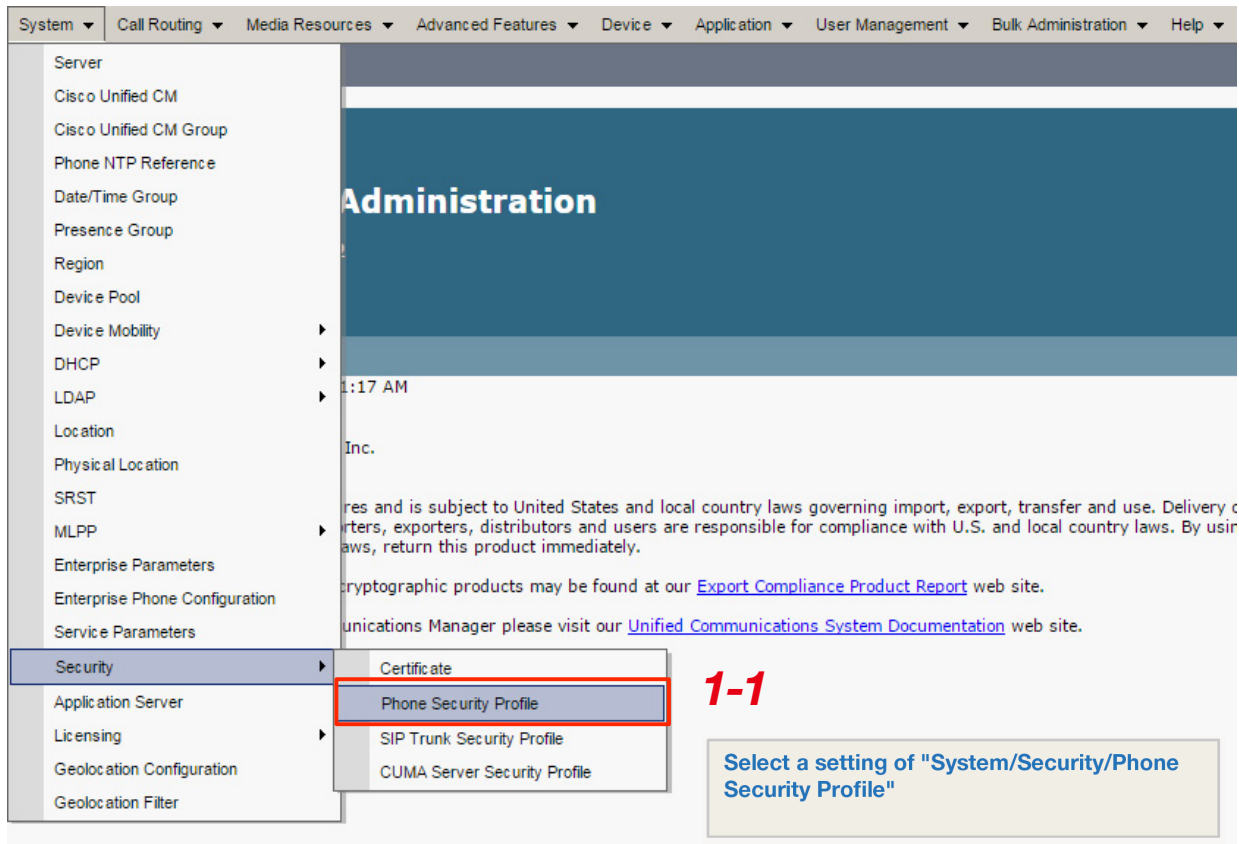

Phone Security Profile Configuration

Save

Status

 Status: Ready

Phone Security Profile Information

Product Type: Third-party SIP Device (Basic)
Device Protocol: SIP

Name* **1-5**
Description
Nonce Validity Time*
Transport Type*

Enable Digest Authentication **1-6**

Parameters used in Phone

SIP Phone Port*

1-7

Full fill boxes as shown in left, specially "Enable Digest Authentication" shall be checked, then save the setting

Step 2. Adding extension number

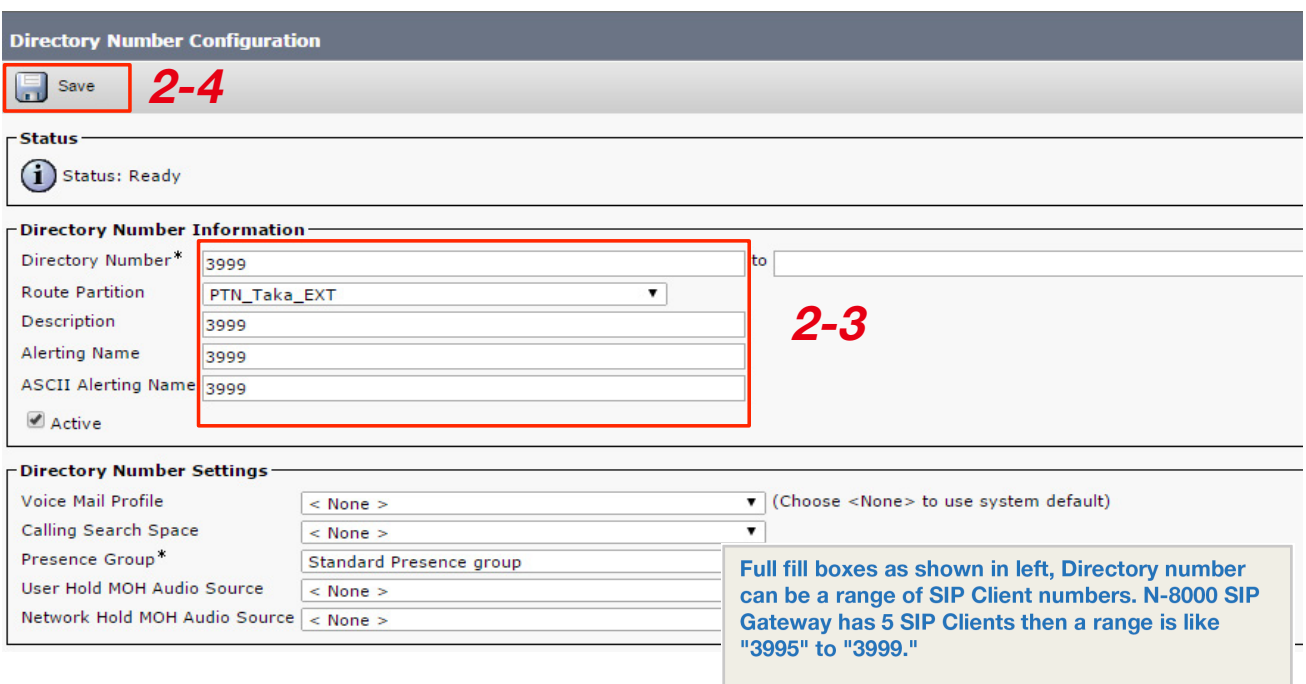
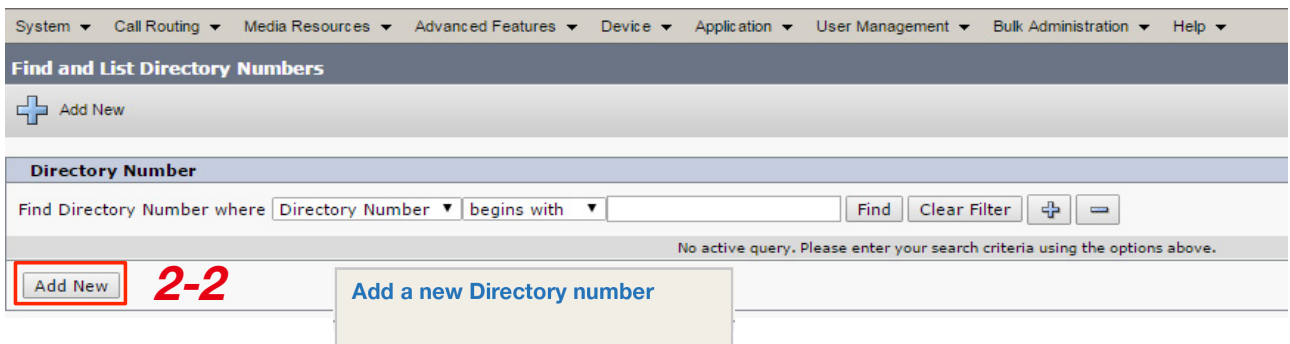
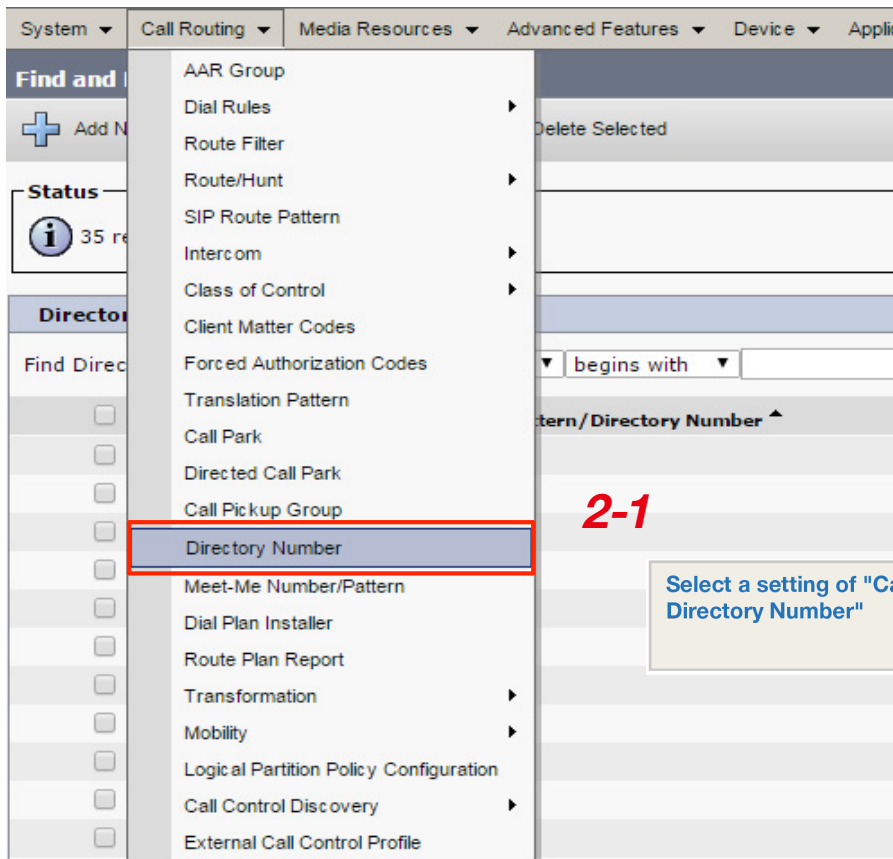

Step 3. Adding SIP Client

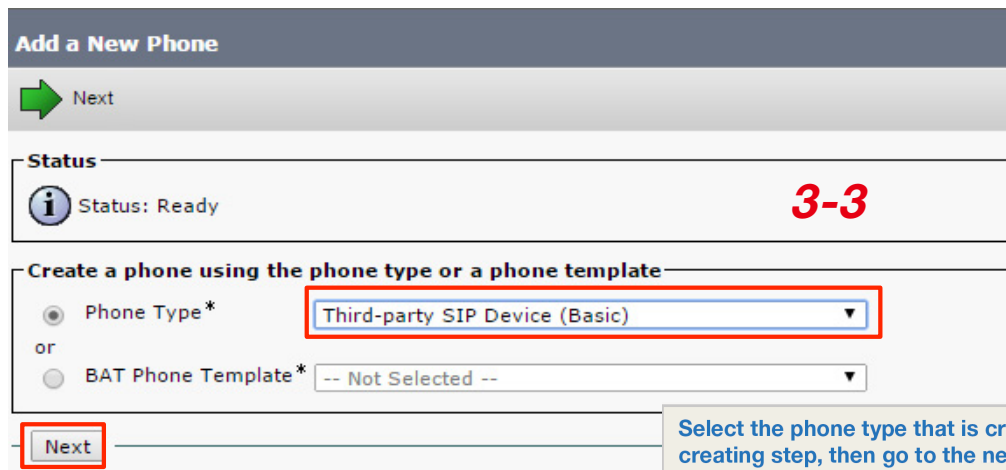
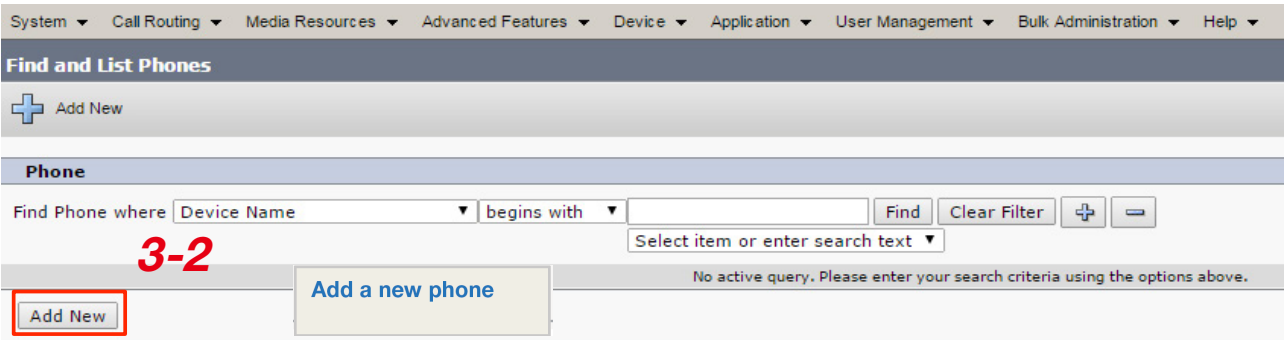
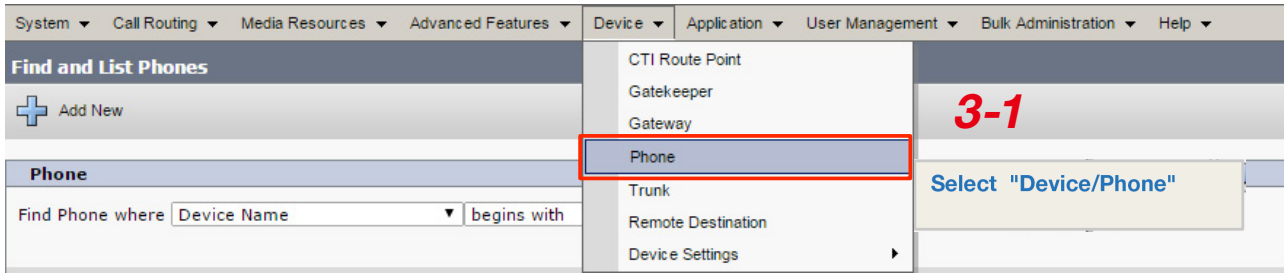

3-4

Phone Configuration

Save

Status
 Status: Ready

Phone Type
 Product Type: Third-party SIP Device (Basic)
 Device Protocol: SIP

Device Information

⚠ Device is not trusted

MAC Address*	000C29CB913B	
Description	SEP000C29CB913B	
Device Pool*	Default	View Details
Common Device Configuration	< None >	View Details
Phone Button Template*	Third-party SIP Device (Basic)	
Common Phone Profile*	Standard Common Phone Profile	
Calling Search Space	CSS Taka EXT	
AAR Calling Search Space	< None >	
Media Resource Group List	< None >	
Location*	Hub_None	
AAR Group	< None >	
Device Mobility Mode*	Default	View Current Device Mobility Settings
Owner User ID	< None >	
Use Trusted Relay Point*	Default	
Always Use Prime Line*	Default	
Always Use Prime Line for Voice Message*	Default	
Calling Party Transformation CSS	< None >	
Geolocation	< None >	

Use Device Pool Calling Party Transformation CSS
 Ignore Presentation Indicators (internal calls only)
 Logged Into Hunt Group
 Remote Device

Full fill boxes as shown in left

3-5

Protocol Specific Information

Presence Group*	Standard Presence group	
MTP Preferred Originating Codec*	711ulaw	
Device Security Profile*	Third-party SIP Device Basic - Digest Required	
Rerouting Calling Search Space	< None >	
SUBSCRIBE Calling Search Space	< None >	
SIP Profile*	Standard SIP Profile	
Digest User	3999	

Media Termination Point Required
 Unattended Port
 Require DTMF Reception

3-6

3-7

MLPP Information

MLPP Domain < None >

Save

3-8

Full fill boxes as shown in left and save it. "Digest User" can be a client that is set by this step, like 3995, 3996, or 3999, e.g. .

Find and List Phones

Status

29 records found

Phone (1 - 29 of 29)

Find Phone where Device Name begins with Find Clear Filter

<input type="checkbox"/>	Device Name(Line) ^	Description	Device Pool	Device Protocol	S
<input type="checkbox"/>	SEP0008E101F47F	SEP0008E101F47F	Default	SIP	Unknown
<input type="checkbox"/>	SEP0008E1028CCF	SEP0008E1028CCF	Default	SIP	Unknown
<input type="checkbox"/>	SEP000C29CB913B	SEP000C29CB913B	Default	SIP	Unknown
<input type="checkbox"/>	SEP04DAD2BFA6FD	SEP04DAD2BFA6FD	DP_Taka_G729	SIP	Registered with 192
<input type="checkbox"/>	SEP100C29CB913B	SEP100C29CB913B			
<input type="checkbox"/>	SEP110C29CB913B	SEP110C29CB913B			

Like shown in left, an added device is on the list. Click the added device

Phone Configuration

Status

Status: Ready

Association Information

Modify Button Items

1 Line [1] - Add a new DN

Phone Type

Product Type: Third-party SIP Device (Basic)
Device Protocol: SIP

Device Information

Registration
IP Address

The left information can be seen. Click the red area

Directory Number Configuration

Save

Status

Status: Ready

Directory Number Information

Directory Number* 3999

Route Partition PTN_Taka_EXT

Description 3999

Alerting Name 3999

ASCII Alerting Name 3999

Active

Directory Number Settings

Voice Mail Profile < None > (Choose <None> to use system default)

Calling Search Space CSS_Taka_EXT

Presence Group* Standard Presence group

User Hold MOH Audio Source < None >

Network Hold MOH Audio Source < None >

Full fill boxes as shown in left

Call Forward and Call Pickup Settings			
	Voice Mail	Destination	Calling Search Space
Calling Search Space Activation Policy			Use System Default
Forward All	<input type="checkbox"/> or		< None >
Secondary Calling Search Space for Forward All			< None >
Forward Busy Internal	<input type="checkbox"/> or	3996	CSS_Taka_EXT
Forward Busy External	<input type="checkbox"/> or	3996	CSS_Taka_EXT
Forward No Answer Internal	<input type="checkbox"/> or	3996	CSS_Taka_EXT
Forward No Answer External	<input type="checkbox"/> or	3996	CSS_Taka_EXT
Forward No Coverage Internal	<input type="checkbox"/> or		< None >
Forward No Coverage External	<input type="checkbox"/> or		< None >
Forward on CTI Failure	<input type="checkbox"/> or		< None >
Forward Unregistered Internal	<input type="checkbox"/> or	3996	CSS_Taka_EXT
Forward Unregistered External	<input type="checkbox"/> or	3996	CSS_Taka_EXT
No Answer Ring Duration (seconds)			
Call Pickup Group		< None >	

3-14

This setting example shows a kind of "practical setting idea" that uses transferring function in case that one SIP client is busy and the others are available and one of others can cover a call instead of a busy station.

*e.g., "ring transferring setting" like 3995 transferred to 3996, 3996 transferred to 3997,, is one of the idea to use easily a function of SIP Gateway.

Multiple Call/Call Waiting Settings on Device SEP000C29CB913B	
Note: The range to select the Max Number of calls is: 1-2	
Maximum Number of Calls*	2
Busy Trigger*	1 (Less than or equal to Max. Calls)

3-15

This setting is for a condition that how many calls can be received by a SIP client. The number is 1 or 2.

Step 4. Adding users

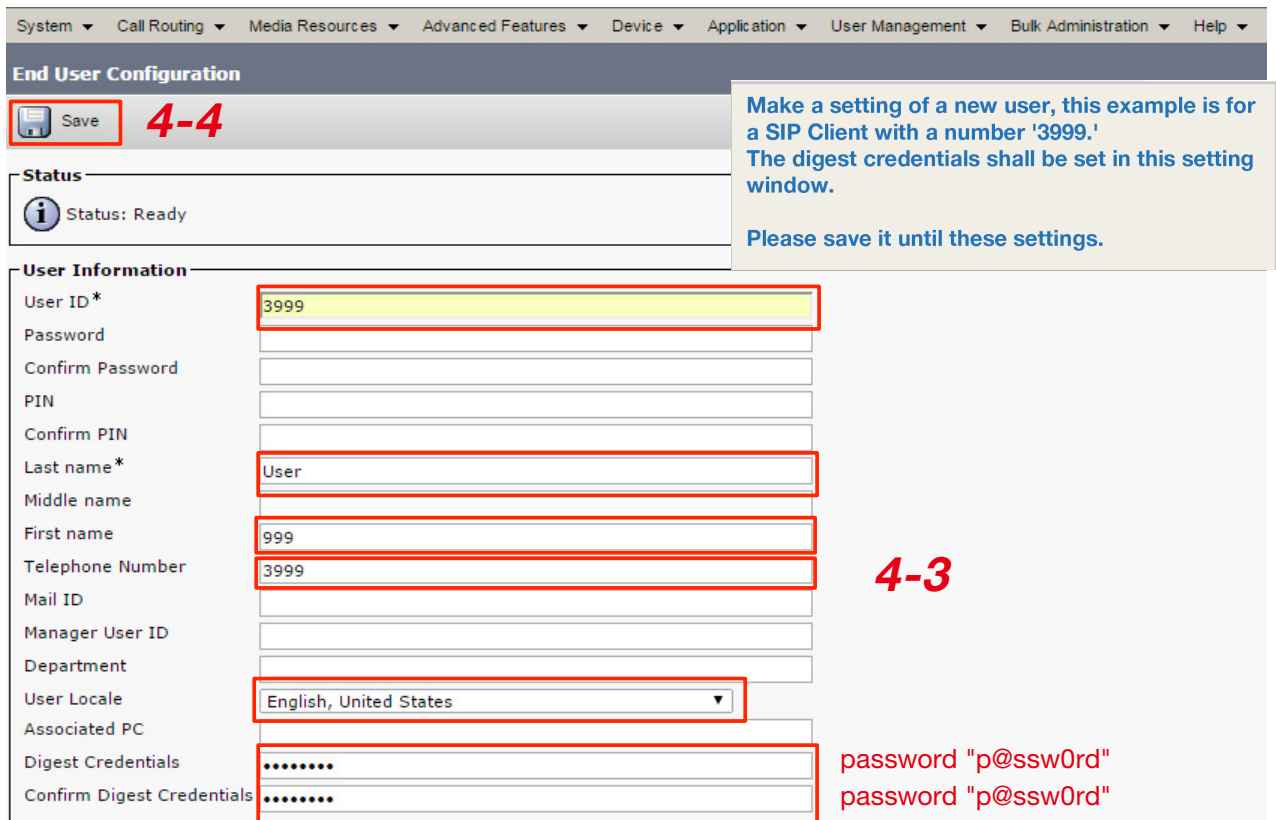
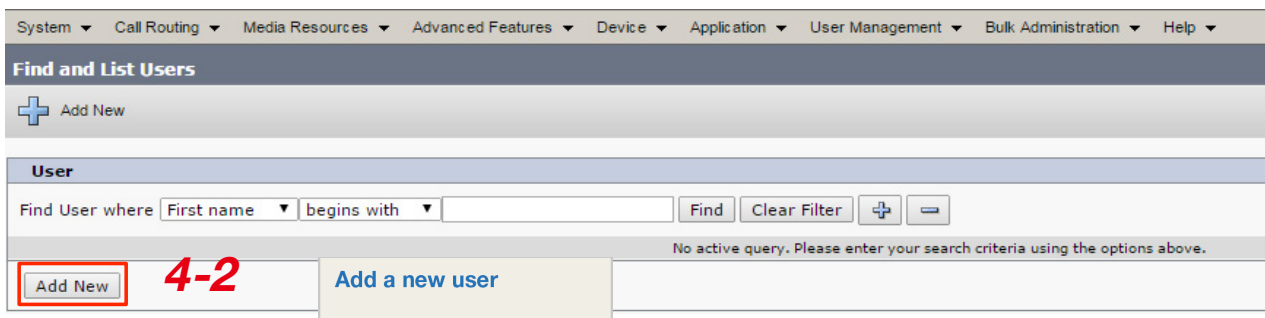
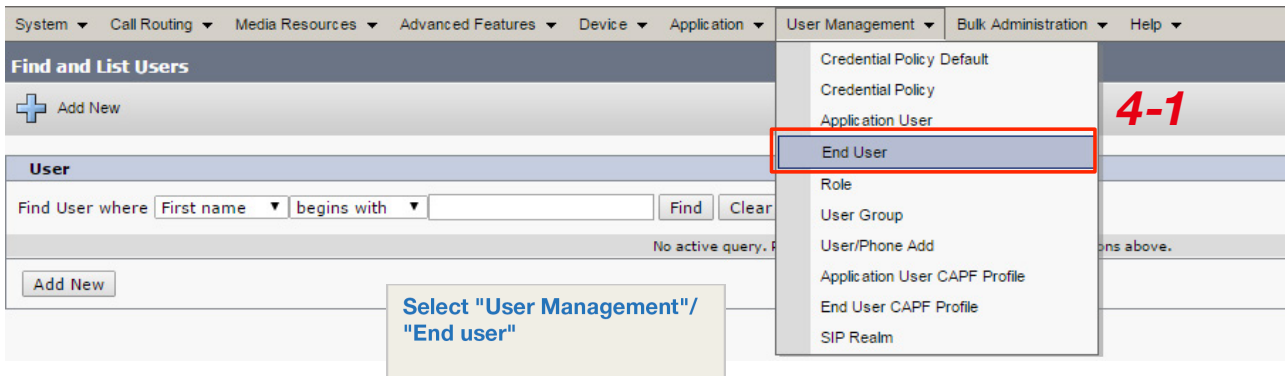

*Until this setting, pressing save is better to continue.

Device Information

Controlled Devices: Device Association

Available Profiles: EM_2000, EM_2001, EM_2002

CTI Controlled Device Profiles:

4-5

Extension Mobility

Available Profiles: EM_2000, EM_2001, EM_2002

Controlled Profiles:

Default Profile: -- Not Selected --

Presence Group*: Standard Presence group

SUBSCRIBE Calling Search Space: < None >

Allow Control of Device from CTI

Enable Extension Mobility Cross Cluster

Select as shown in left, and make a device association

Directory Number Associations

Primary Extension: < None >

Mobility Information

Enable Mobility

Primary User Device: < None >

Enable Mobile Voice Access

Maximum Wait Time for Desk Pickup*: 10000

Remote Destination Limit*: 4

Remote Destination Profiles:

[View Details](#)

CAPF Information

Associated CAPF Profiles:

[View Details](#)

Permissions Information

Groups: Standard CCM End Users

Roles: Standard CCM End Users, Standard CCMUSER Administration

4-6

Add to the group shown in left, and save it.

[View Details](#)

Save

4-7

