

TASCAM

D01209720C

DP-03SD

Digital Portastudio

OWNER'S MANUAL

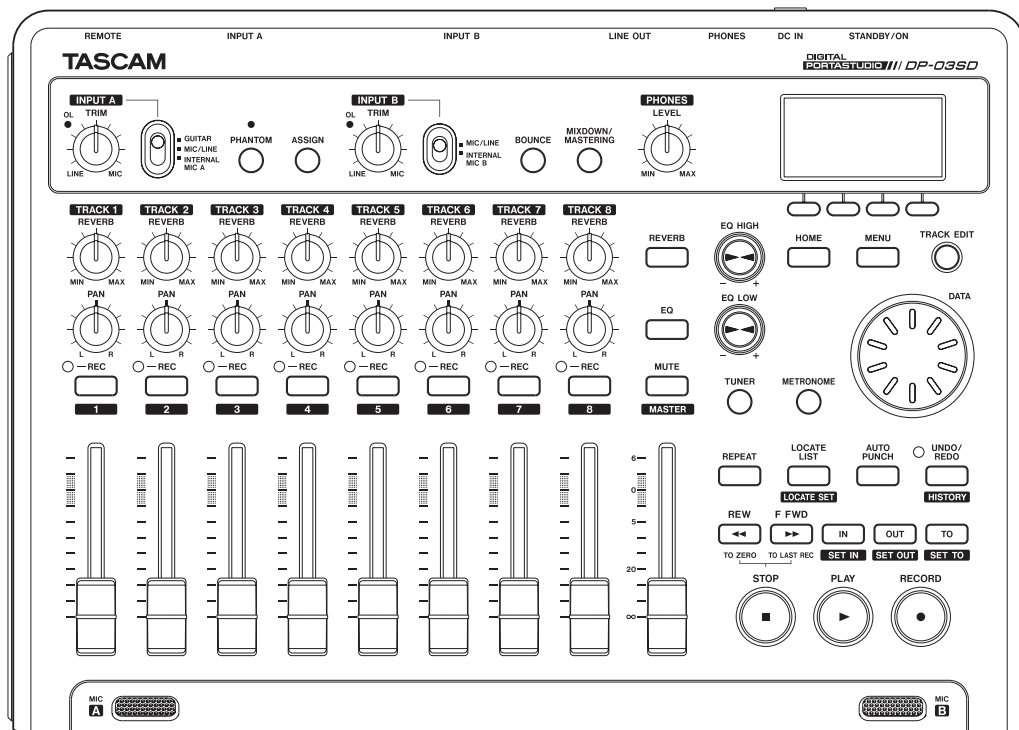

IMPORTANT SAFETY PRECAUTIONS



CAUTION: TO REDUCE THE RISK OF ELECTRIC SHOCK, DO NOT REMOVE COVER (OR BACK). NO USER-SERVICEABLE PARTS INSIDE. REFER SERVICING TO QUALIFIED SERVICE PERSONNEL.



The lightning flash with arrowhead symbol, within equilateral triangle, is intended to alert the user to the presence of uninsulated "dangerous voltage" within the product's enclosure that may be of sufficient magnitude to constitute a risk of electric shock to persons.



The exclamation point within an equilateral triangle is intended to alert the user to the presence of important operating and maintenance (servicing) instructions in the literature accompanying the appliance.

WARNING: TO PREVENT FIRE OR SHOCK HAZARD, DO NOT EXPOSE THIS APPLIANCE TO RAIN OR MOISTURE.

For Canada

THIS CLASS B DIGITAL APPARATUS COMPLIES WITH CANADIAN ICES-003.CET

APPAREIL NUMERIQUE DE LA CLASSE B EST CONFORME A LA NORME NMB-003 DU CANADA.

For U.S.A.

This equipment complies with Part 15 of FCC Rules. Operation is subject to the following two conditions:

- 1) This device may not cause interference and
- 2) This device must accept any interference, including interference that may cause undesired operation of the device.

INFORMATION TO THE USER

This equipment has been tested and found to comply with the limits for a Class B digital device, pursuant to Part 15 of the FCC Rules. These limits are designed to provide reasonable protection against harmful interference in a residential installation. This equipment generates, uses, and can radiate radio frequency energy and, if not installed and used in accordance with the instruction manual, may cause harmful interference to radio communications. However, there is no guarantee that interference will not occur in a particular installation. If this equipment does cause harmful interference to radio or television reception, which can be determined by turning the equipment off and on, the user is encouraged to try to correct the interference by one or more of the following measures.

- a) Reorient or relocate the receiving antenna.
- b) Increase the separation between the equipment and receiver.
- c) Connect the equipment into an outlet on a circuit different from that to which the receiver is connected.
- d) Consult the dealer or an experienced radio/TV technician for help.

CAUTION

Changes or modifications to this equipment not expressly approved by TEAC CORPORATION for compliance could void the user's authority to operate this equipment.

DECLARATION OF CONFORMITY

We, TEAC EUROPE GmbH, Bahnstrasse 12, 65205 Wiesbaden-Erbenheim, Germany declare in own responsibility, the TEAC product described in this manual is in compliance with the corresponding technical standards.



IN USA/CANADA, USE ONLY ON 120 V SUPPLY.

IMPORTANT SAFETY INSTRUCTIONS

- 1 Read these instructions.
- 2 Keep these instructions.
- 3 Heed all warnings.
- 4 Follow all instructions.
- 5 Do not use this apparatus near water.
- 6 Clean only with dry cloth.
- 7 Do not block any ventilation openings. Install in accordance with the manufacturer's instructions.
- 8 Do not install near any heat sources such as radiators, heat registers, stoves, or other apparatus (including amplifiers) that produce heat.
- 9 Do not defeat the safety purpose of the polarized or grounding-type plug. A polarized plug has two blades with one wider than the other. A grounding type plug has two blades and a third grounding prong. The wide blade or the third prong are provided for your safety. If the provided plug does not fit into your outlet, consult an electrician for replacement of the obsolete outlet.
- 10 Protect the power cord from being walked on or pinched particularly at plugs, convenience receptacles, and the point where they exit from the apparatus.
- 11 Only use attachments/accessories specified by the manufacturer.
- 12 Use only with the cart, stand, tripod, bracket, or table specified by the manufacturer, or sold with the apparatus. When a cart is used, use caution when moving the cart/apparatus combination to avoid injury from tip-over.



- 13 Unplug this apparatus during lightning storms or when unused for long periods of time.
- 14 Refer all servicing to qualified service personnel. Servicing is required when the apparatus has been damaged in any way, such as power-supply cord or plug is damaged, liquid has been spilled or objects have fallen into the apparatus, the apparatus has been exposed to rain or moisture, does not operate normally, or has been dropped.

- The apparatus draws nominal non-operating power from the AC outlet with its POWER or STANDBY/ON switch not in the ON position.
- The mains plug is used as the disconnect device, the disconnect device shall remain readily operable.
- Caution should be taken when using earphones or headphones with the product because excessive sound pressure (volume) from earphones or headphones can cause hearing loss.
- If you are experiencing problems with this product, contact TEAC for a service referral. Do not use the product until it has been repaired.

CAUTION

- Do not expose this apparatus to drips or splashes.
- Do not place any objects filled with liquids, such as vases, on the apparatus.
- Do not install this apparatus in a confined space such as a book case or similar unit.
- The apparatus should be located close enough to the AC outlet so that you can easily grasp the power cord plug at any time.
- If the product uses batteries (including a battery pack or installed batteries), they should not be exposed to sunshine, fire or excessive heat.
- CAUTION for products that use replaceable lithium batteries: there is danger of explosion if a battery is replaced with an incorrect type of battery. Replace only with the same or equivalent type.

WARNING

- Products with Class I construction are equipped with a power supply cord that has a grounding plug. The cord of such a product must be plugged into an AC outlet that has a protective grounding connection.

■ For China



“仅适用于海拔2000m以下地区安全使用”



“仅适用于非热带气候条件下安全使用”



“环境保护使用年限”

产品有毒有害物质或元素的名称及含量

机种: DP-03SD		有毒有害物质或元素				
品名	铅 (Pb)	汞 (Hg)	镉 (Cd)	六价铬 (Cr6+)	多溴联苯 (PBB)	多溴二苯醚 (PBDE)
1 CHASSIS部份	○	○	○	○	○	○
2 线材部份	○	○	○	○	○	○
3 PCB Assy部份	×	○	○	○	○	○
4 电源部份	○	○	○	○	○	○
5 附属品部份	×	○	○	○	○	○
6 SEAL部份	○	○	○	○	○	○
7 包装部份	○	○	○	○	○	○

- : 表示该有毒有害物质在该部件所有均质材料中的含量均在 GB/T26572 标准规定的限量要求以下。
- ×: 表示该有毒有害物质至少在该部件的某一均质材料中的含量超出 GB/T26572 标准规定的限量要求。
(针对现在代替技术困难的电子部品及合金中的铅)

Contents

1 – Introduction	6	5 – Song Management.....	30
Features	6	Partitions and songs	30
Items included with this product.....	6	Editing names.....	30
About this manual	6	Loading a saved song.....	30
Intellectual property rights	6	Creating a new song	30
Precautions for placement and use.....	7	Saving a song	30
Beware of condensation.....	7	Viewing song information	31
Cleaning the unit.....	7	Copying songs	31
About SD cards	7	Erasing songs.....	31
Precautions for use	7	Protecting songs	32
Using the TEAC Global Site.....	7	6 – Basic Recording	33
User registration.....	7	Selecting the input sources.....	33
About TASCAM customer support service	7	Using phantom power	33
2 – Quick Start Guides	8	Monitoring input signals.....	33
Playback and mixing.....	8	OL indicators and level meters	34
Preparations.....	8	Assigning inputs.....	34
Listening to the demo song	9	Using input EQ (equalizer)	34
Recording and mastering	10	Making the first recording	35
Creating a new song	10	Multitrack recording	35
Connecting and setting the input sources	11	Prepare tracks for recording	35
Set the guitar as the recording source		Track pan and level settings.....	35
for TRACK 1	11	Input selection and assignment	35
Adjusting and monitoring the input level	11	Setting input levels.....	36
Recording a guitar to TRACK 1	12	Record additional tracks.....	36
Playing back the recording.....	13	Undoing an operation	36
Recording a guitar to TRACK 2	13	Undoing the last operation (single undo).....	36
Recording a vocal to TRACK 3.....	14	Cancelling an undo operation (redo)	36
Mixing the tracks.....	15	Undoing a previous operation (multi-undo)	36
Mastering a stereo track	16	Erasing the operation history	37
Shutting down	18	7 – Recorder Functions	38
3 – Names and Functions of Parts	19	Punching in and out.....	38
Home Screen	24	Using the foot switch to punch in/out	38
Menu structure	24	Setting the foot switch.....	38
Screen operations.....	25	Bouncing tracks.....	39
4 – Preparations	26	Using the bounce function.....	39
Preparing the power and the SD card	26	Confirming the result.....	39
Installing an SD card	26	Locate and search functions	39
Ejecting the card	26	Direct locate function.....	39
Preparing the power	26	Location marks	40
Startup & shutdown.....	27	To set a location mark.....	40
Starting up the unit.....	27	To move to a location mark.....	40
Shutting down	27	To delete a location mark.....	40
Formatting SD cards	27	To edit a location mark.....	40
Recorder modes	28	Return To Zero (TO ZERO) and	
Connecting other equipment	28	Last Recording Position (TO LAST REC).....	41
Rear panel	28	Fast forward/rewind search.....	41
Left side panel.....	29	Repeat playback	41
Adjusting the contrast.....	29	Using IN, OUT and TO points	41

Using repeat playback.....	42
Setting the interval between repetitions.....	42
Automatically punching in and out	43
Rehearsal.....	43
Using auto punch in/out to record	43
8 – Editing Tracks	44
Overview of track editing.....	44
Editing points	44
Basic editing procedures	44
Explanation of items	44
COPY/PASTE	45
COPY/INSERT	45
MOVE/PASTE	46
MOVE/INSERT	46
OPEN (insert silence)	46
CUT (remove part)	47
SILENCE (part erase)	47
CLONE track (track duplication)	47
CLEAN out (track erase).....	47
9 – Mixing down and mastering tracks	48
Mixing down tracks.....	48
Levels and balance	48
Stereo position (panning)	48
Track EQ (equalizer)	48
Reverb	48
Muting tracks	49
Creating a stereo master track	49
Setting the starting and ending points	50
Recording a stereo master track	50
Exiting MIXDOWN mode	50
Checking the stereo master track.....	51
End stereo master track checking.....	51
Mastering the stereo master track	51
Mastering procedures	51
Using mastering EQ (equalizer).....	52
Using mastering compression	52
Using normalize.....	53
Copying the stereo master track	53
Exiting MASTERING mode	53
10 – Miscellaneous Functions	54
Metronome	54
Tuner.....	54
Chromatic tuner mode.....	54
Oscillator mode.....	55
Automatic power saving function	56
Restoring the initial preference settings	56
Viewing information.....	56
11 – SD Card Management	57
Overview of partitions	57
Formatting cards.....	57
Reformatting MTR partitions.....	58
Reformatting the FAT partition.....	58
Viewing the capacity of the MTR partition.....	59
Initializing SD cards	59
12 – Exchanging Data with a Computer	60
Supported operating systems.....	60
Connecting with a computer	60
Disconnecting	60
Song backup and restoration.....	61
Backing-up songs.....	61
Restoring songs	62
Track import and export.....	63
Importing tracks.....	63
Exporting tracks	64
Exporting a stereo master track	65
13 – Mastering compressor settings list	66
Library of mastering compressor presets	66
Masetering compressor parameters list	66
14 – Troubleshooting.....	67
15 – Messages	68
General messages.....	68
16 – Specifications	70
Ratings	70
Audio input/output ratings.....	70
Control input/output ratings.....	70
Audio performance.....	70
Computer requirements.....	70
General	71
Backup memory	71
17 – Commonly-used Functions	73

1 – Introduction

Thank you for your purchase of TASCAM's 8-Track Digital Portastudio, the DP-03SD.

Before connecting and using the unit, please take time to read this manual thoroughly to ensure you understand how to properly set up and connect the unit, as well as the operation of its many useful and convenient functions. After you have finished reading this manual, please keep it in a safe place for future reference.

You can also download the Owner's Manual from the TEAC Global Site (<http://teac-global.com/>).

Features

This unit uses SD cards for multitrack recording of 2 tracks simultaneously with up to 8 tracks of playback. Using the built-in mixer functions, multiple tracks can be mixed down to stereo to create a stereo master track.

Stereo master tracks created this way can be transferred to a computer that is connected by USB.

Moreover, since transferring data between the unit and a computer is possible, in addition to stereo master tracks, you can also copy the data for individual tracks and back up song files to a computer.

- 8-track Digital Portastudio that uses SD cards as recording media
- Uses SD cards as recording media, and supports SDHC standards for large capacity cards of up to 32GB
- Multitrack recorder functions include simultaneous 2-track recording and 8-track playback (44.1 kHz, 16-bit)
- Nine 45-mm faders include eight track faders and one master level fader
- Each track has independent REVERB and PAN adjustments and track selection buttons, as well as volume faders and track select (REC) buttons
- Input on two channels through standard 6.3-mm (1/4") TRS jacks, XLR connectors or built-in microphones
- XLR connectors can supply phantom power
- Built-in microphones can record mono tracks separately or a stereo track together
- High-impedance guitar input supported by the standard jack on INPUT A
- Graphic display (128 x 64 pixel) with backlighting
- Independent two-band equalizers can be used on each input and playback track
- Mixing down to a dedicated master track possible
- Included mastering effects can be used on mixdowns of master tracks
- Reverb effect can be adjusted independently for each playback track
- Automatic punch in and out functions
- Track bounce function
- Track editing functions include COPY, MOVE, OPEN, CUT, SILENCE, CLONE and CLEAN OUT
- Undo and redo functions, including multi-undo (and redo) using an operation history
- Locate mark function
- Tuner and metronome functions
- WAV files and backed-up songs on the FAT partition of the SD card can be moved and copied to a computer connected by USB 2.0
- Punch IN/OUT and other functions can be assigned to and controlled by foot switches (RC-3F, sold separately)

Items included with this product

This product includes the following items.

Take care when opening the package to avoid damaging the items.

Keep the packing materials for transportation in the future.

Please contact the store where you purchased this unit if any of these items are missing or have been damaged during transportation.

- Main unit..... 1
- AC adaptor (TASCAM PS-1225L) 1
- Power cord for AC adaptor 1
- SD card (in the unit) 1
- Owner's manual (this document)..... 1

The warranty is included at the end of this manual.

About this manual

In this manual, we use the following conventions:

- The names of buttons and controls are given in the following typeface: **MENU**.
- Messages on the unit's display are shown like this: MENU
- Characters that appear on a computer display are given in the following light typeface: OK
- The four buttons beneath the LCD display are called function buttons, and are referred to as **F1**, **F2**, **F3** and **F4** from left to right. The functions displayed at the bottom of the screen above the buttons are sometimes shown after the button name in parentheses (e.g. **F4** (▶) button, **F2** (EXEC) button).
- "SD memory card" is sometimes abbreviated as "SD card."
- Additional information is introduced in the styles below when needed:

TIP

Useful hints when using the unit.

NOTE

Explanation of actions in special situation and supplement.

CAUTION

Instructions that should be followed to avoid injury, damage to the unit or other equipment, and loss of data.

Intellectual property rights

- TASCAM and PORTASTUDIO are trademarks of TEAC Corporation, registered in the U.S. and other countries.
- Microsoft, Windows, Windows XP, Windows Vista, Windows 7 and Windows 8 are either registered trademarks or trademarks of Microsoft Corporation in the United States and/or other countries.
- Apple, Macintosh, iMac, Mac OS and Mac OS X are trademarks of Apple Inc.
- Pentium and Intel are trademarks of Intel Corporation in the U.S. and/or other countries.
- Other company names, product names and logos in this document are the trademarks or registered trademarks of their respective owners.

Any data, including, but not limited to information, described herein are intended only as illustrations of such data and/or information and not as the specifications for such data and/or information. TEAC Corporation disclaims any warranty that any use of such data and/or information shall be free from infringement of any third party's intellectual property rights or other proprietary rights, and further, assumes no liability of whatsoever nature in the event of any such infringement, or arising from or connected with or related to the use of such data and/or information.

This product is designed to help you record and reproduce sound works to which you own the copyright, or where you have obtained permission from the copyright holder or the rightful licensor. Unless you own the copyright, or have obtained the appropriate permission from the copyright holder or the rightful licensor, your unauthorized recording, reproduction or distribution thereof may result in severe criminal penalties under copyright laws and international copyright treaties. If you are uncertain about your rights, contact your legal advisor. Under no circumstances will TEAC Corporation be responsible for the consequences of any illegal copying performed using the recorder.

Precautions for placement and use

- The operating temperature should be between 5°C and 35°C (41°F and 95°F).
- Do not install in the following types of places. Doing so could degrade the sound quality and/or cause malfunctions.
 - Places with significant vibrations or that are otherwise unstable
 - Near windows or other places exposed to direct sunlight
 - Near heaters or other extremely hot places
 - Extremely cold places
 - Places with bad ventilation or high humidity
 - Very dusty locations
- Make sure that the unit is mounted in a level position for correct operation.
- Do not place any object on the unit for heat dissipation.
- Avoid installing this unit on top of any heat-generating electrical device such as a power amplifier.

Beware of condensation

If the unit is moved from a cold to a warm place, or used immediately after a cold room has been heated or otherwise exposed to a sudden temperature change, condensation could occur. Should this happen, leave the unit for one or two hours before turning the unit on.

Cleaning the unit

To clean the unit, wipe it gently with a soft dry cloth. Do not wipe with chemical cleaning cloths, paint thinner, ethyl alcohol or other chemical agents to clean the unit as they could damage the surface.

About SD cards

This unit uses SD cards for recording and playback.

SD cards that meet SD/SDHC standards and are at least 512 MB can be used with this unit.

A list of SD cards that have been confirmed for use with this unit can be found on our web site. Please access to a product page of this product from the TEAC Global Site (<http://teac-global.com>) to find the list or contact the TASCAM customer support service.

Precautions for use

SD cards are delicate media. In order to avoid damaging a card or the card slot, please take the following precautions when handling them.

- Do not leave them in extremely hot or cold places.
- Do not leave them in extremely humid places.
- Do not let them get wet.
- Do not put things on top of them or twist them.
- Do not hit them.
- Do not remove or insert an SD card when the power is ON

Using the TEAC Global Site

You can download the Owner's Manual necessary for this unit from the TEAC Global Site (<http://teac-global.com/>).

1. Open the TEAC Global Site (<http://teac-global.com/>).
2. In the TASCAM Downloads section, click the desired language to open the Downloads website page for that language.

NOTE

If the desired language does not appear, click Other Languages.

3. Click the product name in the "Search by Model Name" section to open the Downloads page for that product.
 4. Select and download the Owner's Manual that are needed.
- You can download updates for this unit from the TEAC Global Site:<http://teac-global.com/>In the TASCAM Downloads section, select the desired language to open the Downloads website page for that language.

User registration

Customers in the USA, please visit the TASCAM website (<http://tascam.com/>) to register as a user online.

About TASCAM customer support service

TASCAM products are supported and warrantied only in their country/region of purchase.

To receive support after purchase, on the TASCAM Distributors list page of the TEAC Global Site (<http://teac-global.com/>), search for the local company or representative for the region where you purchased the product and contact that organization. When making inquiries, the address (URL) of the shop or web shop where it was purchased and the purchase date are required. Moreover, the warranty card and proof of purchase might also be necessary.

2 – Quick Start Guides

Playback and mixing

In this section, we will play back the demo song on the included SD card.

When this unit is purchased new, the SD card with the demo song on it is already installed in the unit, but we will start by explaining how to insert an SD card using the procedures below.

Preparations

- 1 Open the SD card slot cover on the left side panel and insert the included SD card into the slot.

CAUTION

Be careful not to forcibly insert the card in the wrong direction. Doing so could damage the slot or the card.

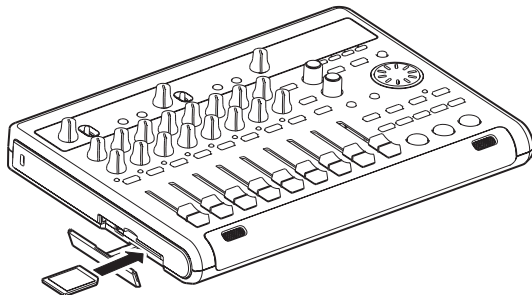

- 2 After inserting the SD card, close the card slot cover.
- 3 Connect the included AC adaptor (TASCAM PS-1225L) to the DC IN 12V connector on the rear panel.

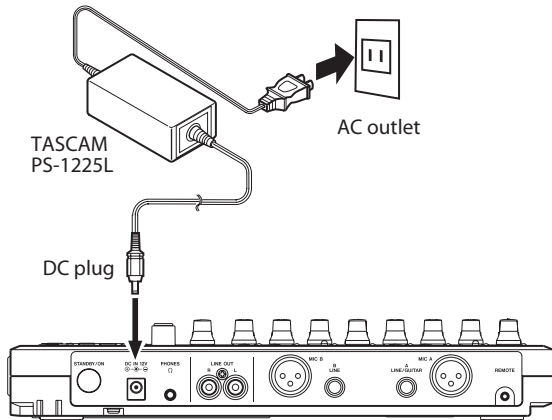

CAUTION

Never use any adaptor other than the TASCAM PS-1225L AC adaptor (included), because it is designed for the power requirements of this unit. Use of a different adaptor could cause malfunction, fire or electric shock.

There is a hook for holding the AC adaptor cord in place (cord holder) on the bottom panel. When using the adaptor, wrap the cord around this hook to prevent it from being disconnected during use.

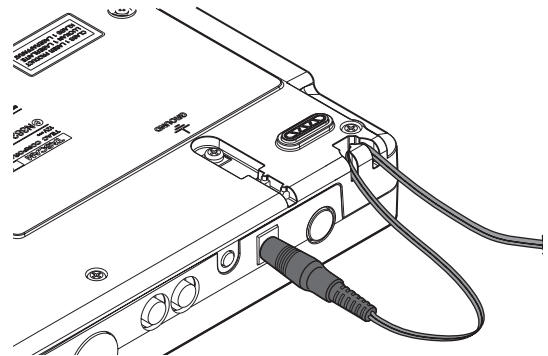

- 4 Connect headphones to the PHONES jack on the rear panel.

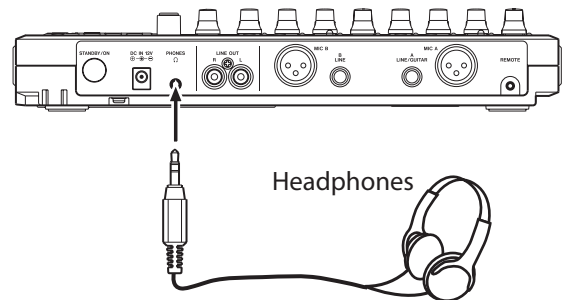

- 5 Press the **STANDBY/ON** button on the rear panel to turn the power ON.

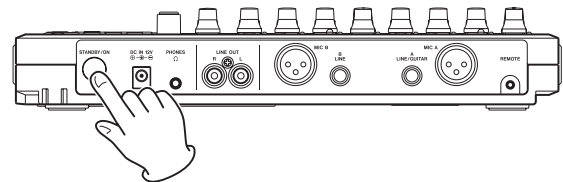

Startup Screen

After the unit starts the Home Screen appears on the display.



Home Screen

CAUTION

- Do not remove or insert an SD card when the power is ON. Always turn the power OFF (standby) before removing or inserting a card.
- If you remove or insert an SD card when the power is ON, all recorded data and settings made since the last time the unit was shut down or a song was saved will be lost. These lost data and settings cannot be recovered.
- When the power is ON, do not cut the power to the unit by disconnecting the power cord, for example.
- Before turning the power ON, minimize the headphones volume and the volume on any monitoring system connected to this unit.

TIP

If an amplifier or powered speakers are connected to the **LINE OUT** jacks, you can monitor using speakers.

Listening to the demo song

The included SD card in the unit contains a demo song. We will use this demo song to practice listening to and mixing a recording.

- Press the **HOME** button to open the Home Screen.

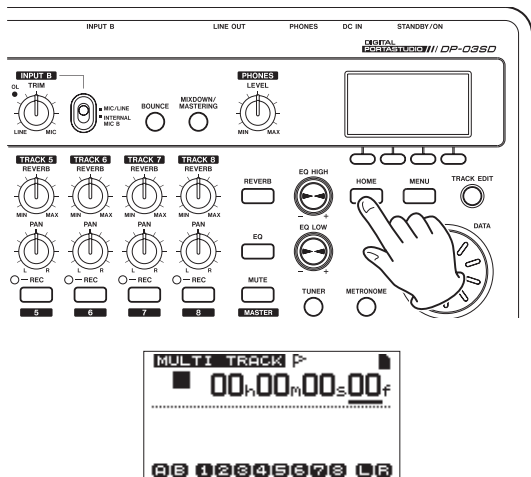

- When the Home Screen is open, press the **MENU** button to open the MENU screen.

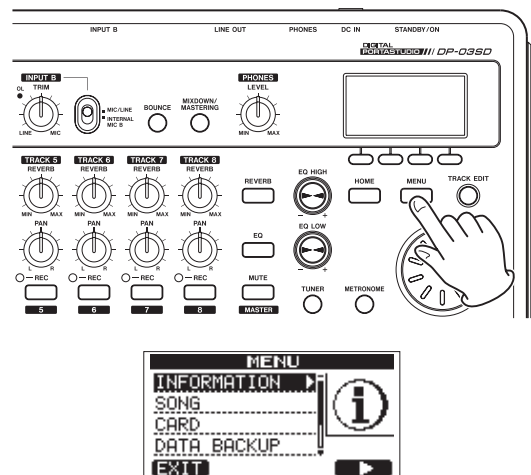

- Use the **DATA** wheel to select the **SONG** menu item and press the **F4** (▶) button to open the **SONG** screen.

NOTE

When an item is selected, it appears as light characters on a dark background.

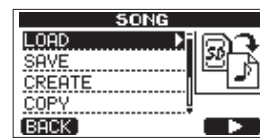
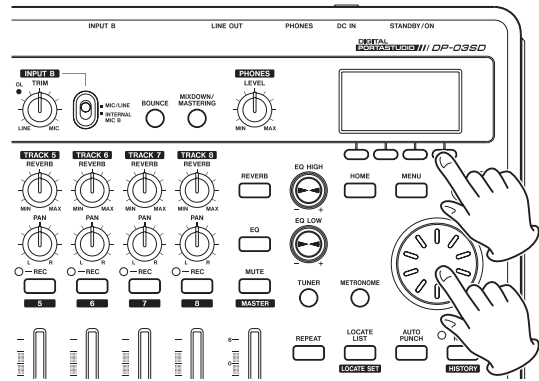

- Use the **DATA** wheel to select the **LOAD** item and press the **F4** (▶) button to open the **SONG LOAD** screen, which shows a list of the songs on the card.

- Use the **DATA** wheel to select **DEMO_03** and press the **F2** (EXEC) button to load the demo song and return to the **SONG** screen.

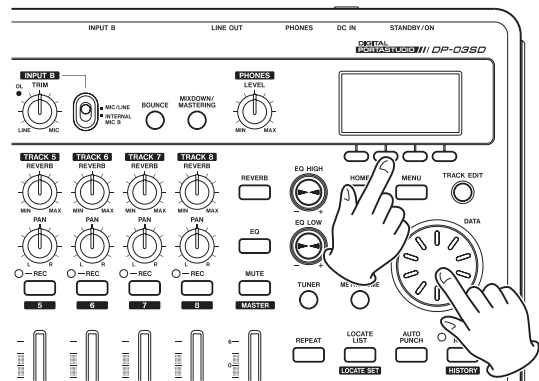

- Press the **HOME** button to return to the Home Screen.

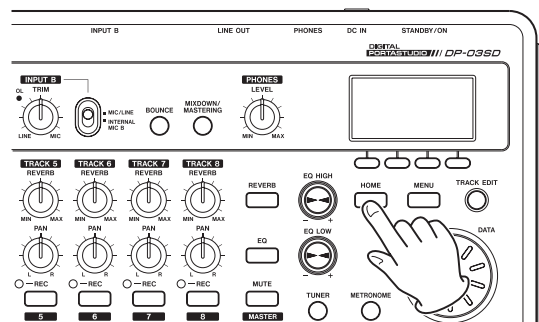

- Press the **PLAY** (▶) button, and raise the **TRACK 1–8** faders, **MASTER** fader and **PHONES LEVEL** knob to listen to the demo song.

2 – Quick Start Guides

The **MASTER** fader adjusts the overall volume of **TRACKS 1–8**. The standard position of the **MASTER** fader is “0”.

Use **TRACK 1–8** faders to adjust the balance of the tracks.

Use the **PHONES LEVEL** knob to adjust the final monitoring volume.

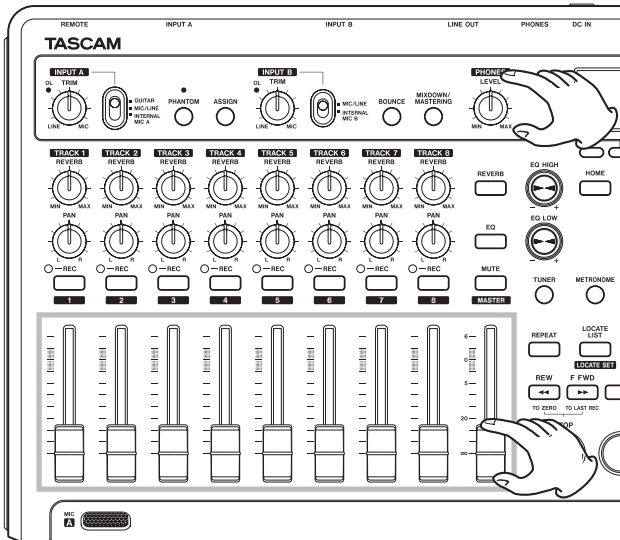

- Use the **TRACK 1–8 PAN** knobs to adjust the stereo position of each track signal.

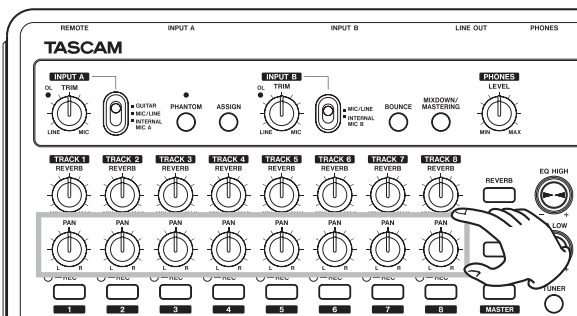

TIP

- Press the **STOP** (■) and **REW** (◀◀) (TO ZERO) buttons at the same time to return to the beginning of the song (ZERO point) (TO ZERO function).
- If you press the wrong button and open a different screen, press the **HOME** button to return to the Home Screen at any time.

Recording and mastering

In this section we will practice multitrack recording. In the following example, we will explain how to record a rhythm guitar part with an electric guitar to track 1 and a lead guitar part to track 2. Then, we will use the built-in microphone to record vocals to track 3. Finally, we will mix down the tracks to stereo.

In this section, we assume that you have already followed the instructions in the previous section, and that you have connected monitoring equipment, started the unit and installed the SD card.

TIP

*This example uses the built-in mic for recording vocals, but you could also connect an external mic to the **INPUT A** or **INPUT B** connector on the rear panel and record with it.*

Creating a new song

- When the recorder is stopped, press the **MENU** button to open the **MENU** screen.

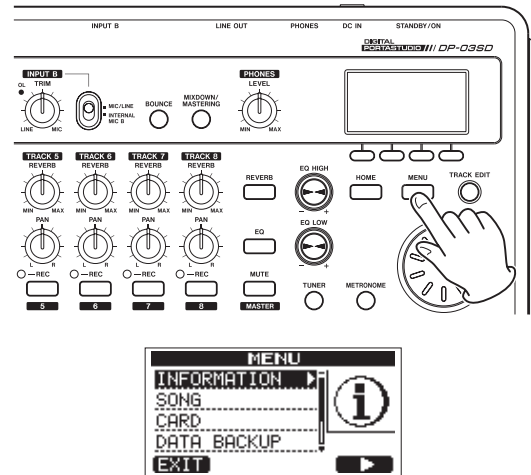

- Use the **DATA** wheel to select the **SONG** item, and press the **F4** (▶) button to open the **SONG** screen.

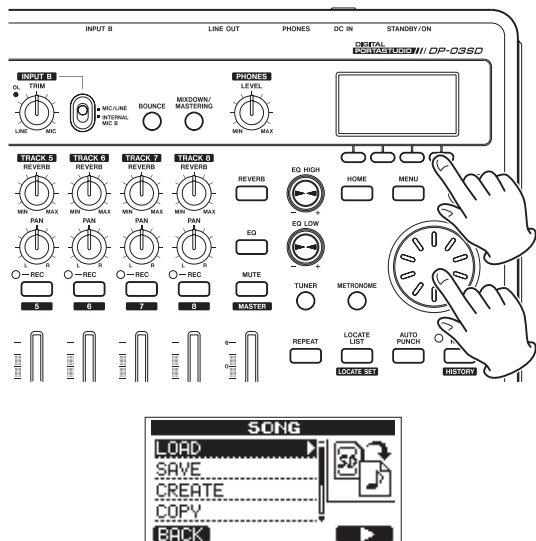

- Use the **DATA** wheel to select the **CREATE** item, and press the **F4** (▶) button to open the **SONG CREATE** screen.



The song that has been created is given the name (title) "SONG***" (***) is a number).

- Change the name (title) of the song as necessary. (See "Editing names" on page 30.)
- Press the **F2 (EXEC)** button to save the currently loaded song and create a new song.

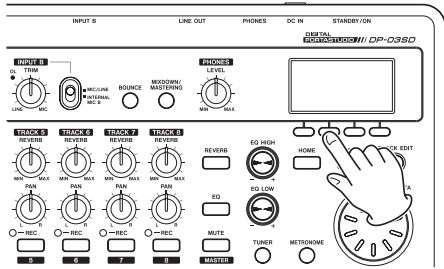

- Press the **HOME** button to return to the Home Screen.

Connecting and setting the input sources

- Connect an electric guitar to the **INPUT A** jack on the rear panel.

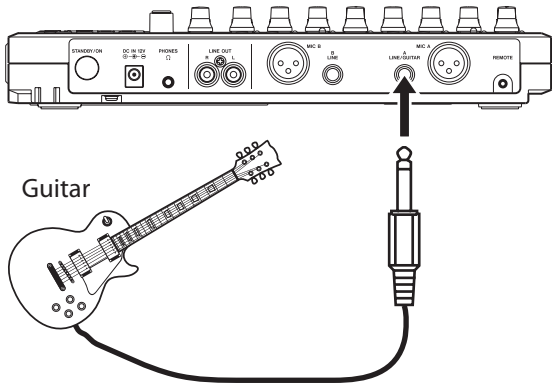

- Set the **INPUT A** switch to **GUITAR**.

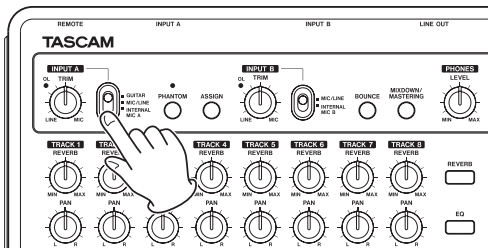

TIP

When connecting an electric-acoustic guitar with a built-in preamp or an active-type electric guitar, or when using an effects pedal, for example, between the guitar and this unit, set in the **INPUT A** switch to **MIC/LINE**.

- Set the **INPUT B** switch to **INTERNAL MIC B** to use the built-in microphone on the right side of the front panel (MIC B) as the input source for **INPUT B**.

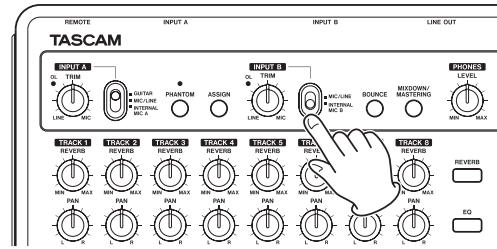

Set the guitar as the recording source for TRACK 1

By default, the recording source for tracks 1, 3, 5 and 7 is set to **INPUT A ("A")**, and the recording source for tracks 2, 4, 6 and 8 is set to **INPUT B ("B")**. See "Assigning inputs" on page 34.

In the "Connecting and setting the input sources" section above, we set a guitar as the input source for **INPUT A** and the built-in microphone (**INTERNAL MIC B**) as the input source for **INPUT B**, so the guitar can be recorded to tracks 1, 3, 5 and 7, while **INTERNAL MIC B** can be recorded to tracks 2, 4, 6 and 8. For this reason, there is no need to change the input assignments in this example in order to record a guitar to track 1.

Adjusting and monitoring the input level

- Press the **HOME** button to return to the Home Screen.

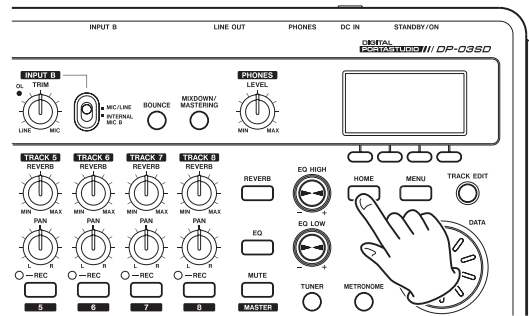

- Press the **TRACK 1 REC** button. The **TRACK 1 REC** indicator blinks and the unit enters record standby.

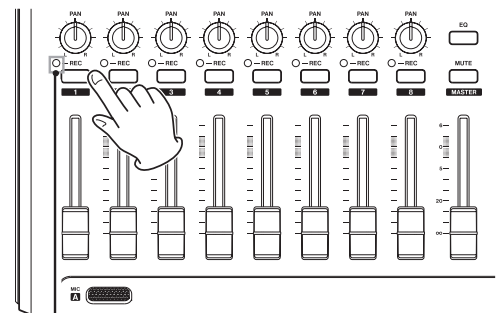

TRACK 1 REC indicator

2 – Quick Start Guides

- Use the **INPUT A TRIM** knob to adjust the guitar input level. Set the **TRIM** knob so that the **OL** indicator for **INPUT A** does not light even when the loudest sound to be recorded is input.

If the **OL** indicator continues to light even when the **TRIM** knob is turned down, the guitar signal itself is too loud. In this case, lower the output level on the guitar.

OL indicator

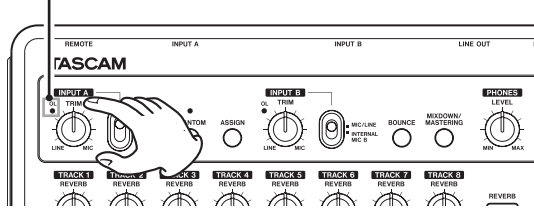

When you play guitar, the input level is shown by the level meters for "A" (INPUT A) and "1" (TRACK 1) on the display.



When you raise the **TRACK 1** fader, the **MASTER** fader and the **PHONES LEVEL** knob, you can hear the sound of the guitar through the headphones, and the **A** and **1** level meters move.

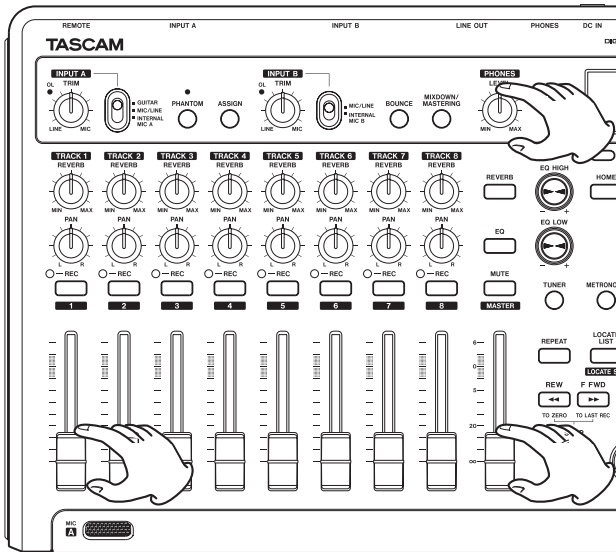

NOTE

- Use the **TRACK 1 PAN** knob to set the stereo position when monitoring.
- When the **TRACK 1 REC** indicator is unlit, the input cannot be heard.

Recording a guitar to TRACK 1

- Press and hold the **RECORD** (●) button and press the **PLAY** (▶) button to start recording. Play the guitar. The **TRACK 1 REC** indicator stop blinking and stays lit.

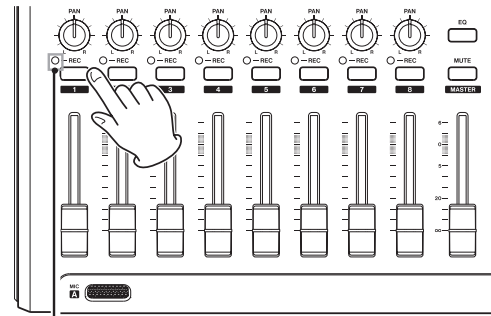

TRACK 1 REC indicator

- When you are done performing, press the **STOP** (■) button to stop recording.
- Press the **TRACK 1 REC** button to end record standby. Its **REC** indicator becomes unlit.

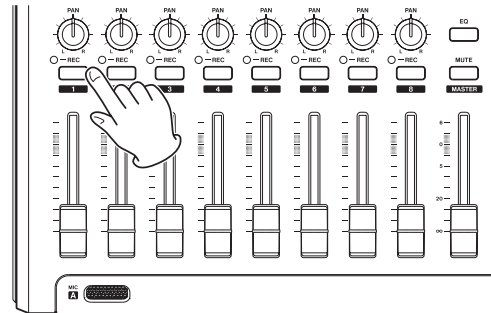

Playing back the recording

- 1 To return to the beginning of the song (ZERO point), press and hold the **STOP** (■) button and press the **REW** (◀) (**TO ZERO**) button (**TO ZERO** function).
- 2 Press the **PLAY** (▶) button to play back the recording on **TRACK 1**.
- 3 Use the **TRACK 1** fader and the **MASTER** fader to adjust the playback monitoring level. Use the **PHONES LEVEL** knob to adjust the final monitoring volume.

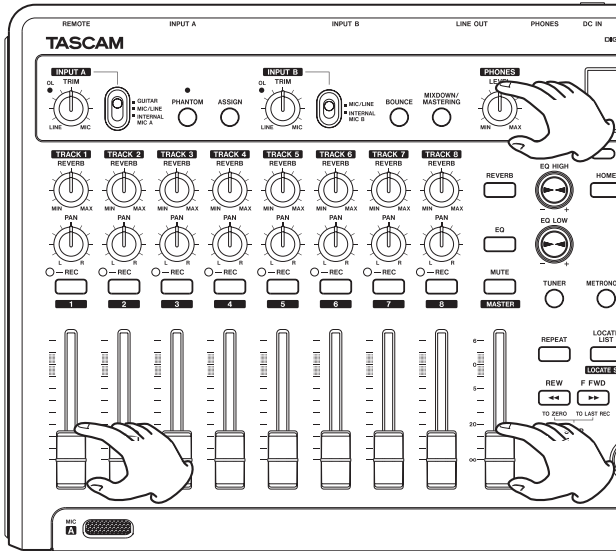

TIP

Use the **TRACK 1 PAN** knob to set the stereo position when monitoring.

Recording a guitar to TRACK 2

We will listen to the rhythm guitar on **TRACK 1** as we record the lead guitar on **TRACK 2**.

Follow these procedures to change the recording source.

- 1 Press the **ASSIGN** button to open the **INPUT ASSIGN** screen.

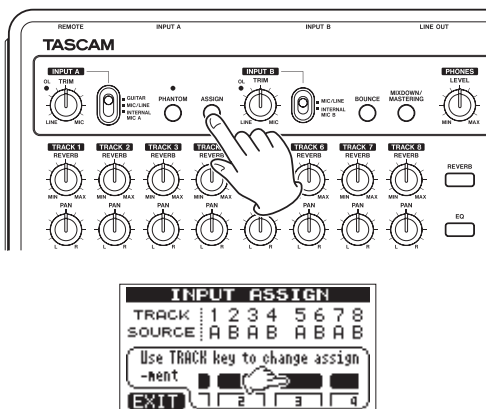

On this page you can set the recording source for each track to **INPUT A** or **INPUT B**.

By default, the recording source for tracks 1, 3, 5 and 7 is set to **INPUT A** (A), and the recording source for tracks 2, 4, 6 and 8 is set to **INPUT B** (B).

- 2 Press the **TRACK 2 REC** button to set the **SOURCE** for **TRACK 2** to **A**.

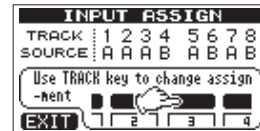
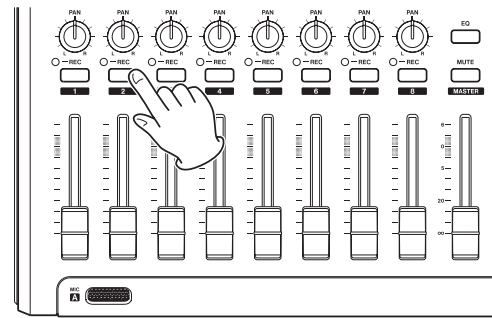

- 3 Press the **HOME** button to return to the Home Screen.

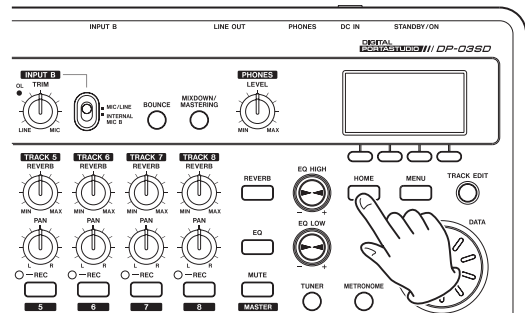

- 4 Press the **TRACK 2 REC** button. The **TRACK 2 REC** indicator blinks and the unit enters record standby. When you play guitar, the input level is shown by the level meters for "A" (**INPUT A**) and "B" (**TRACK 2**) on the display.

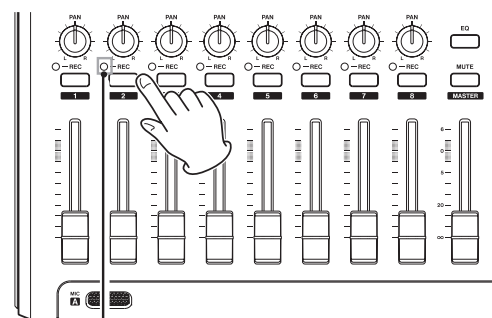

TRACK 2 REC indicator



2 – Quick Start Guides

- Return to the beginning of the song and start playback of the recorded rhythm guitar. Play the lead guitar part along with the recording.
Raise the **TRACK 2** fader to hear both the playback of **TRACK 1** and input guitar signal through your headphones.

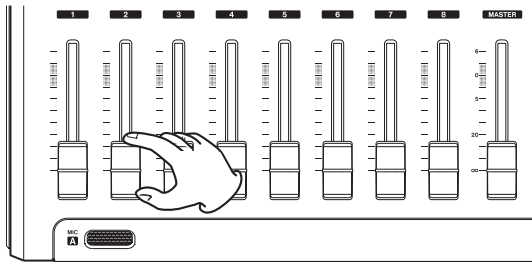

- As necessary, use the **TRACK 1** and **2** faders, **PAN** knobs, **MASTER** fader and **PHONES LEVEL** knob to adjust the monitoring level and balance.

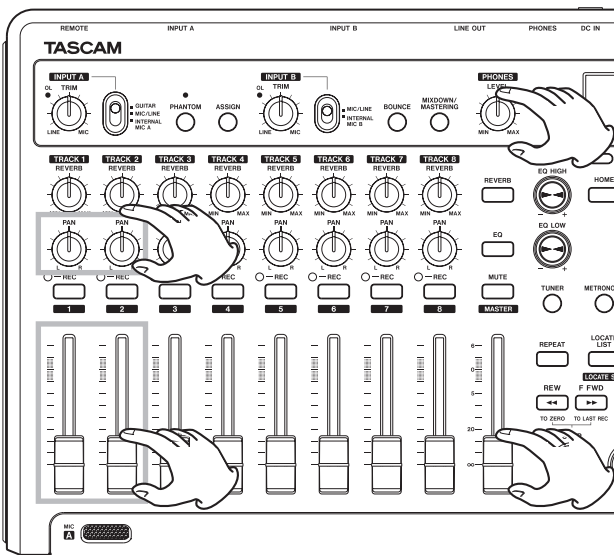

- Return to the beginning of the song, press and hold the **RECORD** (●) button and press the **PLAY** (▶) button to start recording. Perform the lead guitar part.
The **RECORD** (●) button lights red, and the **TRACK 2 REC** indicator stops blinking and stays lit.
- When you are done performing, press the **STOP** (■) button to stop recording.
- Press the **TRACK 2 REC** button to end record standby. Its **REC** indicator becomes unlit.

Recording a vocal to TRACK 3

- Press the **ASSIGN** button to open the **INPUT ASSIGN** screen.

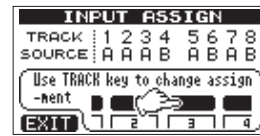
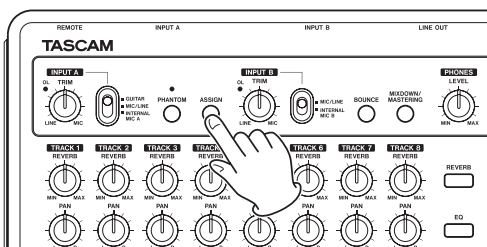

- Press the **TRACK 3 REC** button to set the **SOURCE** for **TRACK 3** to **B**.

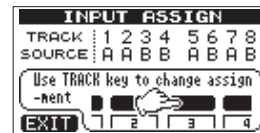
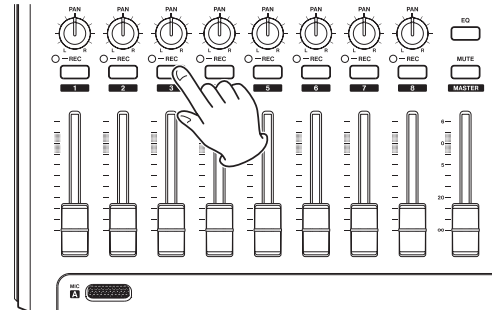

- Press the **HOME** button to return to the Home Screen.

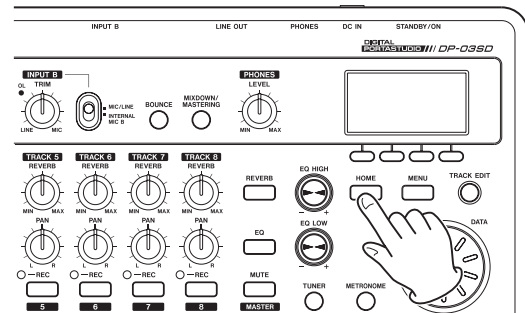

- Press the **TRACK 3 REC** button.
Its **REC** indicator blinks and the unit enters record standby.

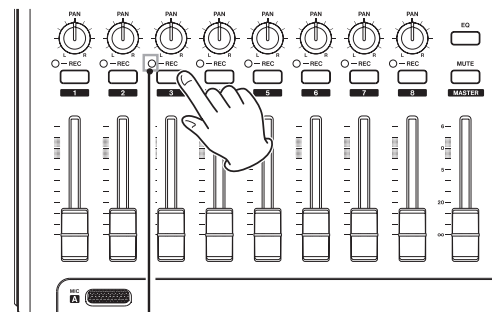

TRACK 3 REC indicator

2 – Quick Start Guides

- Use the **TRIM** knob for **INPUT B** to adjust the input level suitably for the mic.
Set the **TRIM** knob so that the **OL** indicator for **INPUT B** does not light even when the loudest sound to be recorded is input.

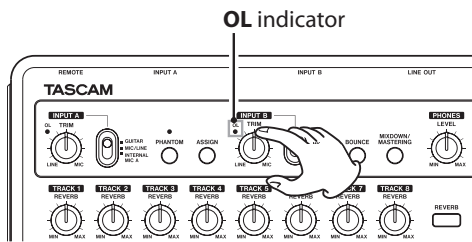

When you input a sound through built-in **MIC B**, the input level is shown by the “**B**” level meter.



When you raise the **TRACK 3** fader, the **MASTER** fader and the **PHONES LEVEL** knob, you can hear the sound of the mic input through the headphones

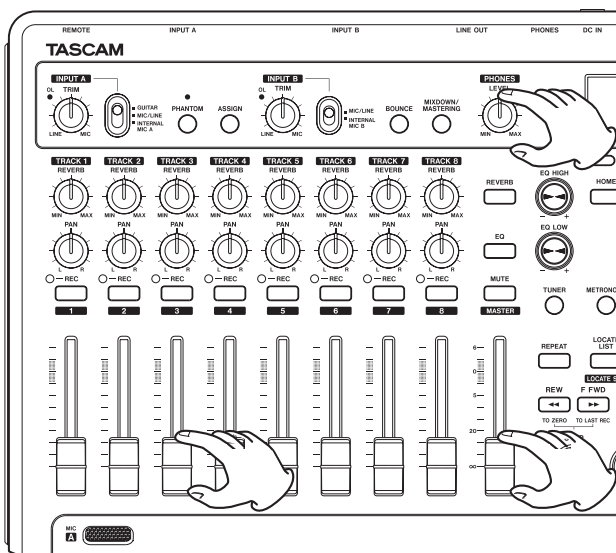

NOTE

If the **OL** indicator continues to light even when the **TRIM** knob is turned down, the mic signal itself is too loud. In this case, move the mic further away from the sound source or lower the volume of the sound source.

CAUTION

- Always monitor through headphones when using a mic. If you monitor through speakers, feedback could occur.
- Return to the beginning of the song, and start playback of the recorded rhythm guitar and lead guitar parts. Sing along with the recordings.
You can hear the playback of the recorded guitar parts on tracks 1 and 2 along with the vocal on your headphones.

- As necessary, use the **TRACK 1** and **2** faders, **PAN** knobs, **MASTER** fader and **PHONES LEVEL** knob to adjust the monitoring level and balance.

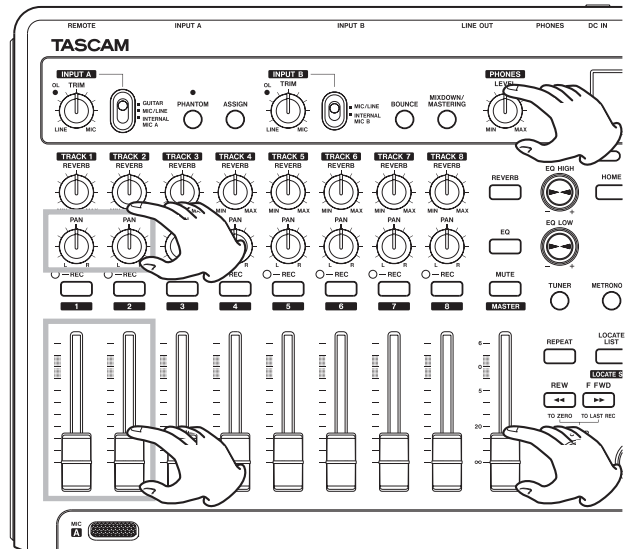

- Return to the beginning of the song, press and hold the **RECORD** (●) button and press the **PLAY** (▶) button to start recording. Sing your song.
The **RECORD** (●) button lights red, and the **TRACK 3 REC** indicator stops blinking and stays lit.
- When you are done singing, press the **STOP** (■) button to stop recording.
- Press the **TRACK 3 REC** button to end record standby. Its **REC** indicator becomes unlit.

Mixing the tracks

After you finish recording, the next step is to make a stereo mix.

- Use the **TRACK 1–3** faders to adjust their levels and balance. Use the **MASTER** fader to adjust the overall level.

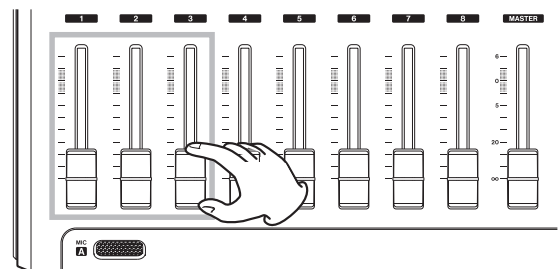

- Use the **TRACK 1–3 PAN** knobs to adjust the stereo positions of each track.

Watch the **L** and **R** meters on the display as you make adjustments.

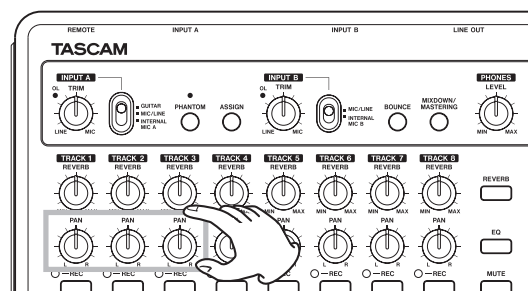

2 – Quick Start Guides

3 Set the IN point.

The time from the IN point to the OUT point will be used for the stereo master track.

Play back the song and press and hold the **IN [SET IN]** button at the point where you want to start the stereo master track. The **SET IN !** pop-up appears.

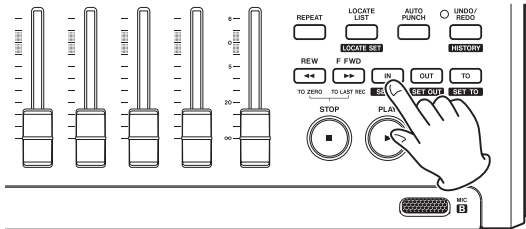

The time when you began to press and hold the **IN [SET IN]** button is set as the IN point, which is where the mix down will start.

4 Set the OUT point.

Play back the song and press and hold the **OUT [SET OUT]** button at the point where you want to end the stereo master track. The **SET OUT !** pop-up appears.

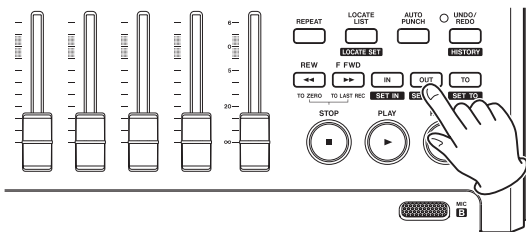

The time when you began to press and hold the **OUT [SET OUT]** button is set as the OUT point, which is where the mix down will end.

TIP

*You can also use the **IN [SET IN]** and **OUT [SET OUT]** buttons to set the IN and OUT points when playback is stopped.*

5 Press the **MIXDOWN/MASTERING** button to open the **MIXDOWN** screen.

Mixdown mode is enabled and the Home Screen reopens. **MIXDOWN** appears in the upper left.

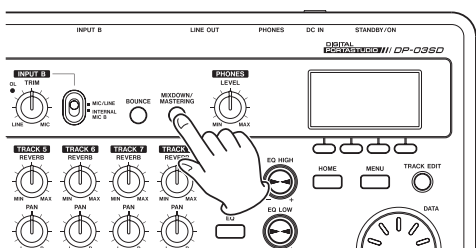

- Press and hold the **RECORD** (●) button and press the **PLAY** (▶) button to start recording a stereo master track. Recording automatically stops when the OUT point is reached.

NOTE

- The **IN** and **OUT** points must be at least 4 seconds apart. If the interval is shorter than 4 seconds, the **Trk Too Short** pop-up appears and mixdown mode cannot be started.
- During recording, you can use the track faders to adjust the levels of the tracks and the overall level.
- You can use the equalizer and reverb effect while recording a stereo master track. (See "Track EQ (equalizer)" on page 48 and "Reverb" on page 48.)
- You can mute unwanted tracks so that they are not recorded to the stereo master track. (See "Muting tracks" on page 49.)

Mastering a stereo track

Mastering is the process of adjusting a stereo master track to improve the final sound.

Confirming the stereo master track

- In multitrack mode, press the **MIXDOWN/MASTERING** button to open the **MASTERING** screen. The unit begins mastering mode and the Home Screen reopens. **MASTERING** appears in the upper left.

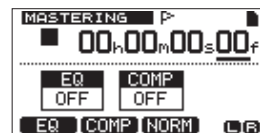
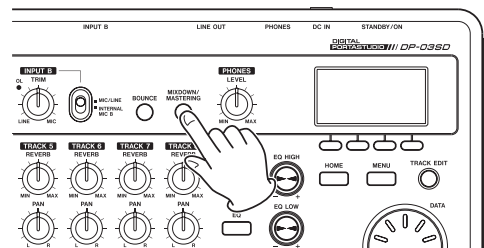

NOTE

- Mastering mode cannot be started if you have not created a stereo master track.
- From multitrack mode, press the **MIXDOWN/MASTERING** button once to enter mixdown mode and once again to enter mastering mode.

- In this mode, press the **PLAY** (▶) button to listen to the stereo master track that you have created.

NOTE

- Confirm that both the **EQ** and **COMP** items are shown to be **OFF**. If either is **ON**, the sound heard will be affected by the equalizer and/or compressor. (See "Using mastering

EQ (equalizer)” on page 52 and “Using mastering compression” on page 52.)

- In MASTERING mode, the MASTER fader cannot be used to adjust the level.

■ Applying equalization

In this example, we will use the equalizer on the master track to reduce high frequencies and increase low frequencies slightly.

- 1 In mastering mode, press the **F1 (EQ)** button to open the MASTERING EQ screen.

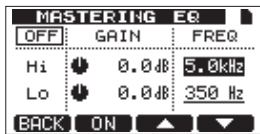
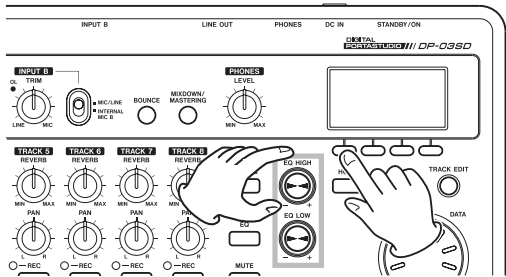

- 2 Turn the **EQ HIGH** knob to the left to lower the Hi GAIN knob shown on the screen. Set the value to -2.0dB to reduce the high frequencies.
- 3 Next, turn the **EQ LOW** knob to the right to increase the Lo GAIN knob shown on the screen. Set the value to $+6.0\text{dB}$ to increase the low frequencies.

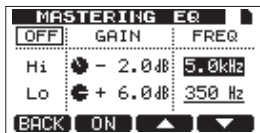

- 4 Press the **F2 (ON)** button to turn the equalizer ON. The word OFF at the top left of the screen changes to ON.
- 5 Press the **F1 (BACK)** button to return to the Home screen.
- 6 Press the **PLAY (▶)** button to listen to the stereo master track with equalization.

■ Applying compression

Use the compressor on the stereo master track to adjust the impact of the entire song.

- 1 In mastering mode, press the **F2 (COMP)** button to open the MASTERING COMP screen.

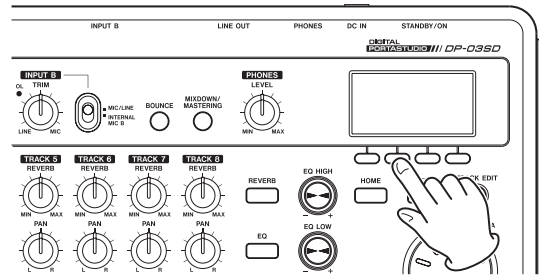

- 2 Press the **F3 (LIB)** button to open the library list.

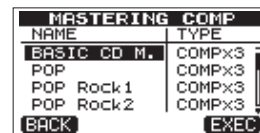
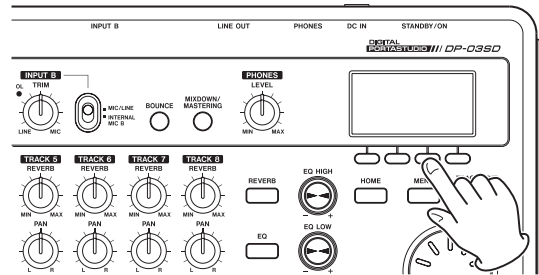

- 3 Use the **DATA** wheel to select POP ROCK 1 and press the **F4 (EXEC)** button to return to the MASTERING COMP screen.



TIP

Press the **F4 (P.ARM)** button to open the screen where you can also adjust the parameters of the compressor.

- 4 Press the **F2 (ON)** button to turn the compressor ON. The word OFF at the top left of the screen changes to ON.



2 – Quick Start Guides

- 5 Press the **F1 (BACK)** button to return to the Home screen.
- 6 Press the **PLAY (▶)** button to listen to the stereo master track with compression.

NOTE

If the **EQ** item is also **ON**, the effect of the equalizer on the sound will also be heard.

Normalizing the stereo master track

Normalizing maximizes the volume of the stereo master track.

- 1 In mastering mode, press the **F3 (NORM)** button to open the **NORMALIZE** screen.

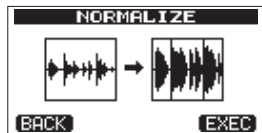
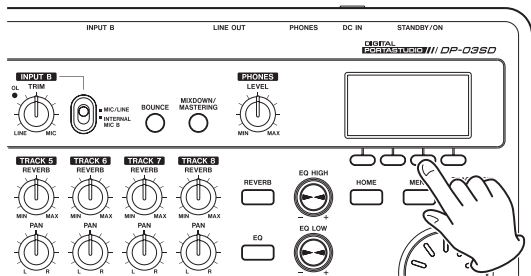

- 2 Press the **F4 (EXEC)** button to normalize the track.
- 3 Press the **F1 (BACK)** button to return to the Home screen.

Rerecord the stereo master track

Record the master track with equalization and compression applied to create a new stereo master track.

- 1 In mastering mode, press and hold the **RECORD (●)** button and press the **PLAY (▶)** button.
- 2 This will record over the master and create a new stereo master track with equalization and compression applied.

Shutting down

Turn the unit off when you are done using it.

- 1 Press the **HOME** button to open the Home Screen.

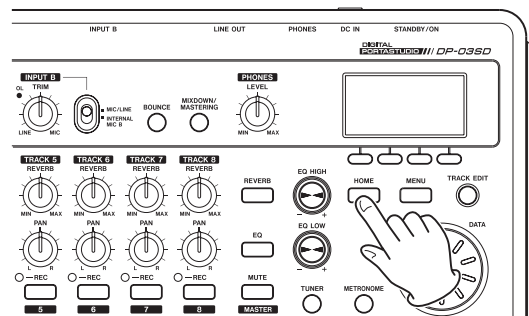

- 2 Press and hold the **STANDBY/ON** button on the rear panel until **PORTASTUDIO** appears on the display.



When the unit completes its automatic shutdown procedures, which includes recording various information about the operations that have been conducted until now, the power turns OFF (standby).

Always use the procedures above to turn the power off properly.

CAUTION

If you cut the power to the unit by disconnecting the power cord, for example, all recorded data and settings made since the last time the unit was shut down or a song was saved will be lost. These lost data and settings cannot be recovered.

3 – Names and Functions of Parts

Top panel

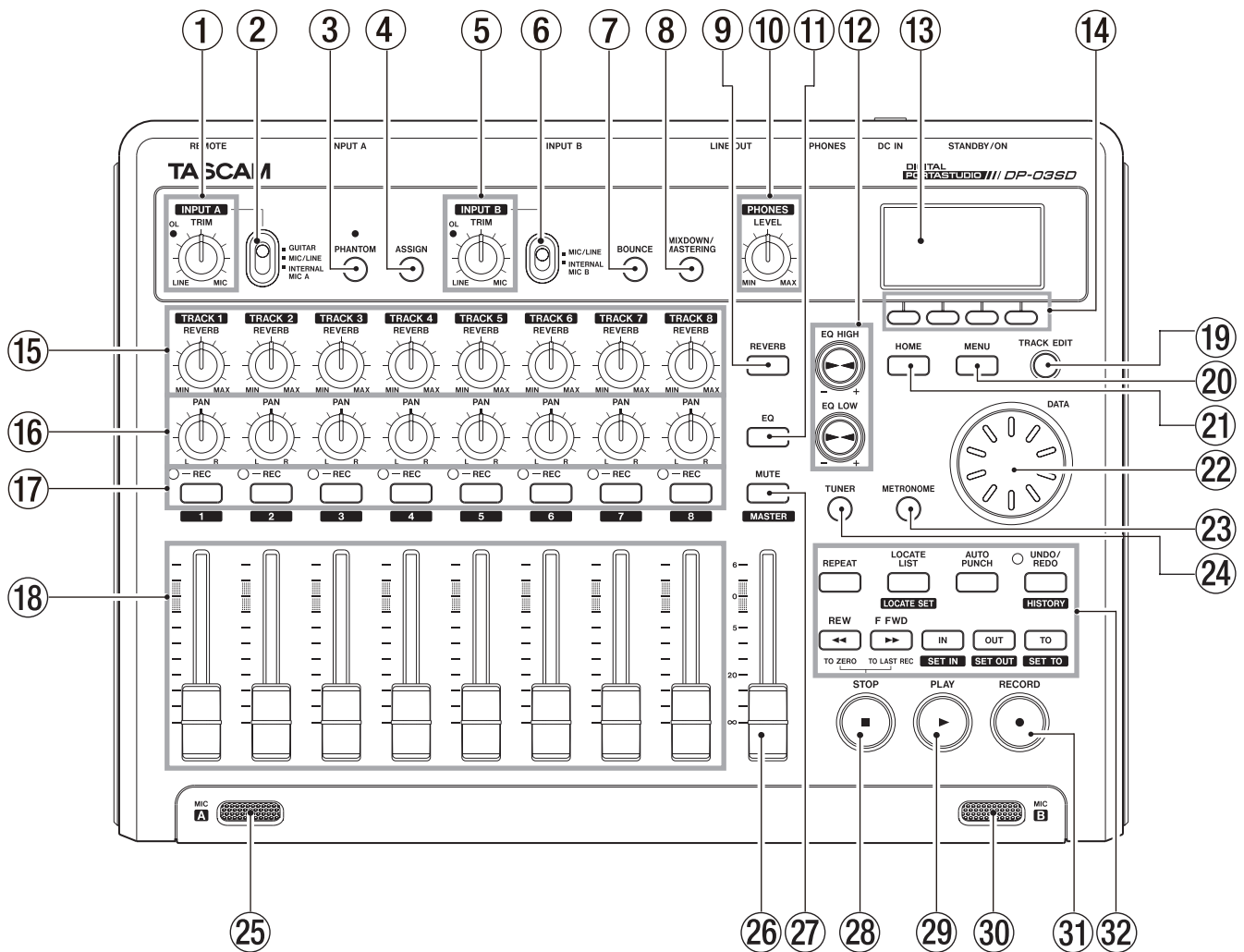

- ① **TRIM knob/OL indicator (INPUT A)**
Use this **TRIM** knob to adjust the input level of **INPUT A**. (See “Making the first recording” on page 35.)
If the input source signal is too loud, the **OL** (overload) indicator lights.
- ② **INPUT A switch**
Set this according to the signal source input through the **INPUT A — MIC A** connector or **LINE A/GUITAR** jack on the rear panel. Set it to **GUITAR** when connecting an electric guitar or electric bass directly. Set it to **MIC/LINE** when connecting a microphone or line level signal. Set it to **INTERNAL MIC A** when using built-in **MIC A**.
- ③ **PHANTOM button/indicator**
Press this button to open the **PHANTOM** screen where you can turn phantom power ON and OFF.
The indicator lights when phantom power is ON.

CAUTION

- Use the **MASTER fader** to lower the output volume of the unit before turning phantom power ON or OFF. Depending on the mic, a loud noise could occur, damaging equipment and harming people’s hearing.
- Do not connect or disconnect a mic when phantom power is ON.

- Turn this switch ON only when using a condenser microphone that requires phantom power.
 - Do not supply phantom power to an unbalanced dynamic microphone.
 - Supplying phantom power to some types of ribbon microphones could break them. Do not supply phantom power to a ribbon microphone if you are in doubt.
- ④ **ASSIGN button**
Use this button to set the input assignment (**INPUT A** and **INPUT B**) of a track. Press this button to open the **INPUT ASSIGN** screen on the display. The input signal of the assigned input becomes the recording source. (See “Assigning inputs” on page 34.)
 - ⑤ **TRIM knob/OL indicator (INPUT B)**
Use this **TRIM** knob to adjust the input level of **INPUT B**. (See “Making the first recording” on page 35.)
If the input source signal is too loud, the **OL** (overload) indicator lights.
 - ⑥ **INPUT B switch**
Set this according to the signal source input through the **INPUT B — MIC B** connector or **LINE B** jack on the rear panel. Set it to **MIC/LINE** when connecting a microphone or line level signal. Set it to **INTERNAL MIC B** when using built-in **MIC B**.

3 – Names and Functions of Parts

- ⑦ **BOUNCE button**
Press this button to switch between MULTITRACK and BOUNCE modes.
- ⑧ **MIXDOWN/MASTERING button**
Press this button to switch between MULTITRACK, MIXDOWN and MASTERING modes.
- In MULTITRACK mode, press this button to switch to MIXDOWN mode.
 - In MIXDOWN mode, press this button to switch to MASTERING mode if there is a stereo master track or to return to MULTITRACK mode if not.
 - In MASTERING mode, press this button to return to MULTITRACK mode.

NOTE

A pop-up appears when the mode changes.

- ⑨ **REVERB button**
Press to open the REVERB SETTING screen where you can adjust reverb parameters. (See “Reverb” on page 48.)
- ⑩ **PHONES LEVEL knob**
Use this to adjust the headphones output volume.
- ⑪ **EQ button**
Press to open the EQ SETTING screen where you can adjust track EQ parameters. (See “Track EQ (equalizer)” on page 48.)
After opening the EQ SETTING screen with this button, press **F1 (INPUT)** to open the INPUT EQ screen where you can adjust input EQ parameters. (See “Using input EQ (equalizer)” on page 34.)
- ⑫ **EQ HIGH/EQ LOW knobs**
Use **EQ HIGH** knob to adjust high-frequency gain on EQ setting screens, including the EQ SETTING, INPUT EQ and MASTERING EQ screens.
Use **EQ LOW** knob to adjust the low-frequency gain on EQ setting screens, including the EQ SETTING, INPUT EQ and MASTERING EQ screens.
- ⑬ **Display**
This shows various types of operation information.
- ⑭ **Function buttons**
The functions of these buttons depend on the screen currently displayed. The current function assignments are shown at the bottom of the screen.

NOTE

For convenience, the four function buttons are referred to in order from the left as F1, F2, F3 and F4 in this manual.

- ⑮ **REVERB knobs (TRACK 1–TRACK 8)**
Use to adjust the level (volume) sent to the reverb effect of the track’s playback signal or the input signal assigned to that track.
- ⑯ **PAN knobs (TRACK 1–TRACK 8)**
Use to adjust the stereo position of the track’s playback signal or the input signal assigned to that track. (See “Stereo position (panning)” on page 48.)
- ⑰ **REC buttons/indicators (TRACK 1–TRACK 8)**
Use to arm a track for recording (turn recording ON/OFF). To monitor a track’s input sound through headphones or a monitoring system, press that track’s **REC** button. When the track is armed for recording (**REC** button ON), the **REC**

indicator blinks when the unit is stopped and lights when recording.

On the INPUT ASSIGN screen, press these buttons to change the assignment.

On the TRACK MUTE screen, press these buttons to mute and unmute the tracks.

Press these buttons when the TRACK EQ screen is open to select tracks.

- ⑱ **Track faders (TRACK 1–TRACK 8)**
Use to adjust the monitoring level of the track’s playback signal or the input signal assigned to the track. (See “Levels and balance” on page 48.)
- ⑲ **TRACK EDIT button**
Press this to open the TRACK EDIT MENU screen. (See “8 – Editing Tracks” on page 44.)
- ⑳ **MENU button**
Press this to open the MENU screen.
- ㉑ **HOME button**
Press this to open the Home Screen.
When the unit is stopped and the Home Screen is open, use this button to move between the time counter divisions. (See “Direct locate function” on page 39.)
- ㉒ **DATA wheel**
Use this to change parameter values and select items when using menus.
- ㉓ **METRONOME button**
Press this to open the METRONOME screen. (“Metronome” on page 54.)
- ㉔ **TUNER button**
Press this to open the TUNER screen. (See “Tuner” on page 54.)
- ㉕ **MIC A**
This built-in omnidirectional microphone becomes the input source for **INPUT A** when set to **INTERNAL MIC A**.
When using the tuner, use this built-in microphone to input the sound of the instrument being tuned.

3 – Names and Functions of Parts

- 26 MASTER fader**
Use to adjust the stereo signal level output from the **LINE OUT** jacks and **PHONES** jack. Use also to adjust the recording level when bouncing or mixing down tracks.
- 27 MUTE button**
Press to open the **TRACK MUTE** screen. (See “Muting tracks” on page 49.)
- 28 STOP (■) button**
Press to stop playback, recording and searching forward/backward.

Press at the same time as you press the **REW (◀◀) (TO ZERO)** button or **F FWD (▶▶) (TO LAST REC)** button to locate the beginning of the song (ZERO point) or the last position that recording started (last recording position). (See “Locate and search functions” on page 39.)
- 29 PLAY (▶) button/indicator**
Press this button to start playback.

To start recording, press and hold the **RECORD (●)** button and press this button. During recording, press this button to stop recording and start playback (punch out).

During playback or recording, this indicator lights.
- 30 MIC B**
This built-in omnidirectional microphone becomes the input source for **INPUT B** when set to **INTERNAL MIC B**.

This built-in microphone does not function when using the tuner.
- 31 RECORD (●) button/indicator**
To start recording, press and hold this button and press the **PLAY (▶)** button. During recording, this indicator lights.

During playback, if you press this button when a track **REC** indicator is blinking, recording to that track will begin (punch in). (See “Automatically punching in and out” on page 43.)
- 32 Various function buttons**

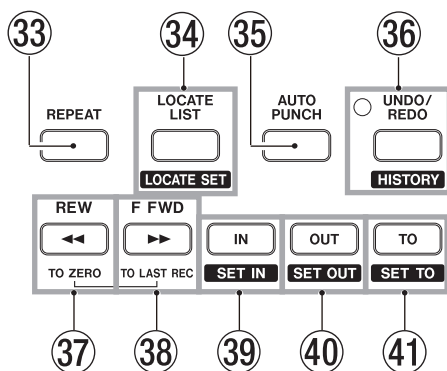

- 33 REPEAT button**
Press to turn repeat playback mode ON and OFF.
(See “Repeat playback” on page 41.)
- 34 LOCATE LIST [LOCATE SET] button**
Press this to open the **LOCATE LIST** screen. If the current song does not contain any location marks, press this to open the **I/O SETTING** screen.

Press and hold this button to add a mark at the current location.
- 35 AUTO PUNCH button**
Press to turn the auto punch mode ON and OFF.

When auto punch mode is active, **(M.Punch)** appears on the screen. (See “Automatically punching in and out” on page 43.)

- 36 UNDO/REDO [HISTORY] button/indicator**
Press this button to undo the immediately previous action (single undo) or cancel a single undo (redo). (See “Undoing an operation” on page 36.)

After a single undo or multi-undo, the **UNDO/REDO** indicator lights, showing that an operation has been undone.

Press and hold this button to open the **HISTORY** screen where you can view the recording and editing history and also conduct multi-undo operations.
- 37 REW (◀◀) (TO ZERO) button**
When stopped, press this button to search backwards. Press it repeatedly to change the speed from 10x to 50x, 100x and 1000x.

During playback, press this button to search backward while pressing.

Press and hold the **STOP (■)** button and press this button to locate to the beginning of the song (ZERO point = 00:00:00:00). (See “Locate and search functions” on page 39.)
- 38 F FWD (▶▶) (TO LAST REC) button**
When stopped, press this button to search forward. Press it repeatedly to change the speed from 10x to 50x, 100x and 1000x.

During playback, press this button to search forward while pressing.

Press and hold the **STOP (■)** button and press this button to locate to the last position that recording started (**TO LAST REC**). (See “Locate and search functions” on page 39.)
- 39 IN [SET IN] button**
Press this button to locate to the IN point.

Press and hold this button to set the playback position at that moment as the IN point.
- 40 OUT [SET OUT] button**
Press this button to locate to the OUT point.

Press and hold this button to set the playback position at that moment as the OUT point.
- 41 TO [SET TO] button**
Press this button to locate to the TO point.

Press and hold this button to set the playback position at that moment as the TO point.

3 – Names and Functions of Parts

Rear panel

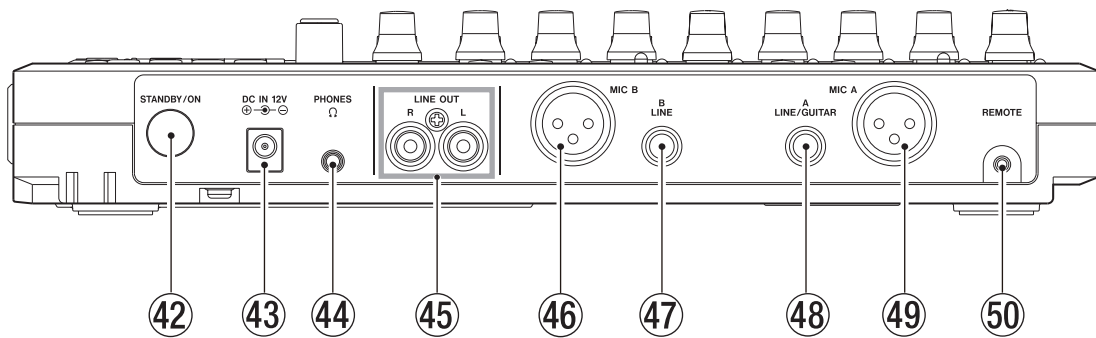

42 STANDBY/ON button

When the power is in standby, press this button to turn it ON. When ON, press and hold this button to put the power into standby. (See “Startup & shutdown” on page 27.)

43 DC IN 12V jack

Connect the dedicated AC adaptor (PS-1225L).

44 PHONES jack (stereo mini jack)

Connect headphones. Use the **PHONES LEVEL** knob on the top panel to adjust the volume.

45 LINE OUT jacks (unbalanced RCA)

Use these to connect a monitoring system (powered speakers or an amplifier with speakers).

46 INPUT B connector (balanced XLR)

This is an input source when the **INPUT B** switch on the top panel is set to **MIC/LINE**.

This is an XLR-type mic/line input jack.

You can also connect a condenser microphone that requires phantom power.

(1: GND, 2: HOT, 3: COLD)

NOTE

Do not input signals into both the XLR and standard jacks at the same time.

47 INPUT B jack (balanced TRS standard jack)

This is an input source when the **INPUT B** switch on the top panel is set to **MIC/LINE**.

You can input a line-level signal (balanced/unbalanced) or mic signal (balanced/unbalanced).

48 INPUT A jack (balanced TRS standard jack)

This is an input source when the **INPUT A** switch on the top panel is set to **MIC/LINE** or **GUITAR**.

You can input a guitar/line-level signal (balanced/unbalanced) or mic signal (balanced/unbalanced).

49 INPUT A connector (balanced XLR)

This is an input source when the **INPUT A** switch on the top panel is set to **MIC/LINE**.

This is an XLR-type mic/line input jack.

You can also connect a condenser microphone that requires phantom power.

(1: GND, 2: HOT, 3: COLD)

NOTE

Do not input signals into both the XLR and standard jacks at the same time.

50 REMOTE jack (2.5-mm TS jack)

Connect a TASCAM RC-3F foot switch (sold separately) to allow a variety of remote control operations, including punch in/out (start and stop recording).

3 – Names and Functions of Parts

Left side panel

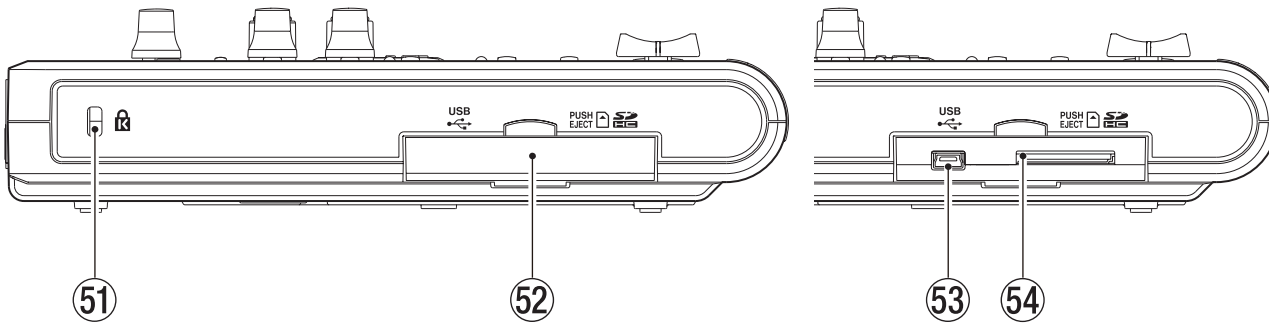

51 **Kensington lock attachment hole**

52 **SD card slot/USB connector cover**

53 **USB port**

Use a USB2.0-compliant mini-B cable to connect the unit with a computer to share files with the computer, including importing and exporting, as well as backing up song files.

(See “Connecting with a computer” on page 60.) (No USB cable is supplied with this unit. Please use one at hand or purchase one is necessary.)

54 **SD card slot**

Insert the SD card into this slot.

Bottom panel

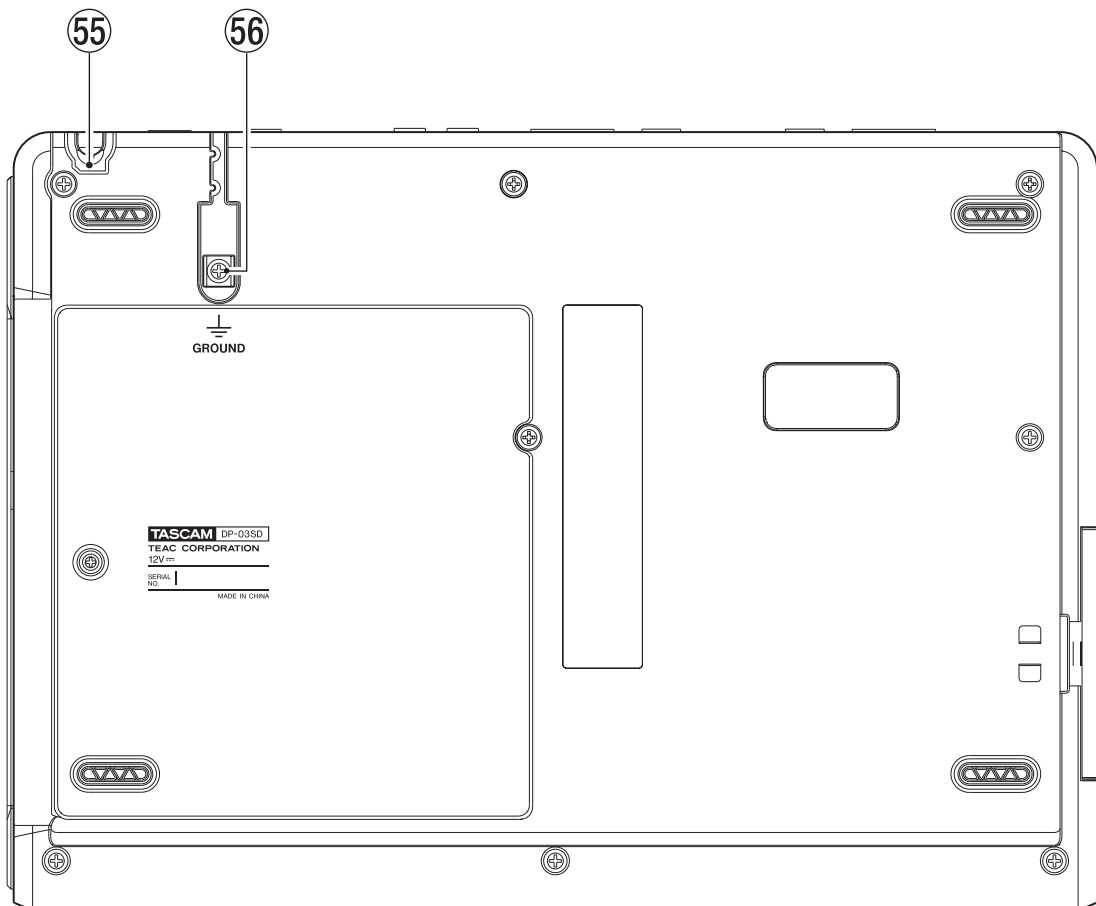

55 **Cord holder**

Wrap the cord of the included TASCAM PS-1225L AC adaptor around this to prevent the plug from becoming disconnected accidentally.

56 **GROUND connector**

Depending on the use environment, you might hear noise when monitoring. If this occurs, use this connector to ground the unit. (Please prepare the necessary wiring yourself.)

3 – Names and Functions of Parts

Home Screen

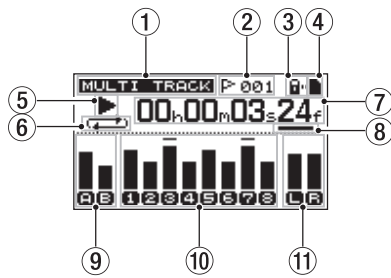

- ① **Recorder mode**
Shows the current recorder mode.
MULTI TRACK
BOUNCE
MIXDOWN
MASTERING
- ② **Location mark number indicator**
The number (001-999) of the current location mark is shown after the **F** flag icon.
- ③ **SD card protection indicator**
If the SD card is protected, the **LOCK** icon appears.
- ④ **SD card insertion status**
If an SD card is inserted **SD** appears. If not, **NO SD** appears.
- ⑤ **Recorder transport state**
When playing **▶** appears. When stopped **■** appears. When recording **●** appears. When searching backward, **◀◀** appears. When searching forward, **▶▶** appears.
- ⑥ **Repeat playback/auto punch mode indicator**
When repeat playback mode is active, **↺** appears.
When auto punch mode is active, **Auto Punch** appears.
- ⑦ **Recorder time counter**
Shows the elapsed time from the start of the song.
- ⑧ **Cursor**
This shows the time increment being edited.
Turning the **DATA** wheel changes the value of the selected time increment. Each time you press the **HOME** button, the cursor moves in order from right to left (f, s, m, h) and back to the right after the hour increment is reached.
- ⑨ **Level meters and EQ status for INPUTS A and B**
Shows the signal levels of **INPUT A** (A) and **INPUT B** (B).
When **INPUT EQ** is ON, A and B are shown with frames (A|B).
- ⑩ **Level meters and mute/track EQ status for TRACKS 1-8**
Shows input levels when recording and playback signal levels when playing back.
When mute is ON, the track number is shown in inverse. For example, **1 2 3 4** means that tracks 3 and 4 are muted.
When muting is OFF and **TRACK EQ** is ON, the track numbers are shown with frames (1|2|3|4).
- ⑪ **Level meter for stereo outputs (L, R)**
Shows the signal level output from the **LINE OUT** jacks.

Menu structure

Press the **MENU** button to open the **MENU** screen, which contains the following items.

Item	Explanation	Reference page
INFORMATION	Shows file information, SD card information and system information.	page 56
SONG	Load, save and create new songs, for example.	page 30
CARD	Format SD cards, for example.	page 57
DATA BACKUP	Backup and restore songs.	page 61
IMPORT/ EXPORT	Import and export tracks and stereo master tracks.	page 63 page 65
PREFERENCE	Make and initialize settings for the repeat playback interval, contrast and foot switch use.	page 29 page 38 page 42 page 56

Use the following dedicated buttons to access specific functions.

Button	Explanation	Reference page
PHANTOM	Turn PHANTOM power ON and OFF.	page 33
ASSIGN	Assign INPUT A or B as the track source.	page 34
BOUNCE	Bounce a track.	page 39
MIXDOWN/ MASTERING	Make and adjust stereo master tracks.	page 49
REVERB	Make reverb settings.	page 48
EQ	Make track and input equalizer settings.	page 34 page 48
MUTE	Mute tracks.	page 49
TUNER	Use to tune instruments	page 54
METRONOME	Use to operate the metronome	page 54
LOCATE LIST [LOCATE SET]	Use to set and jump to marks and IN/OUT/TO points.	page 40
UNDO/REDO [HISTORY]	Press and hold to show the undo/redo history and select undo steps.	page 36
TRACK EDIT	Edit tracks.	page 44

3 – Names and Functions of Parts

Screen operations

Use the **MENU** button and dedicated buttons to open screens. Follow the guidelines below to use the functions on the screens. These examples show basic operation procedures, but the actual assignments of the function buttons vary depending on the screen.

- Use the **DATA** wheel to select the desired item.

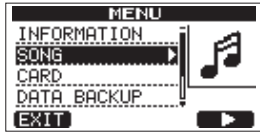

In this example from the **MENU** screen, "SONG" is selected by the **F4 (▶)** button.

NOTE

The assignments of the function buttons are shown at the bottom of the screen above the buttons themselves.

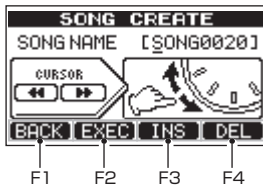

BACK appears above the **F1** button, so the assignment of the **F1** button is "BACK" when using this screen. In this manual, we show this as the "**F1 (BACK)**" button. Likewise, the assignments of the **F2**, **F3** and **F4** buttons are **EXEC**, **INS** and **DEL**, respectively.

- When an item has a sub-screen (the **MENU** screen, for example) a "▶" appears to the right of the item. Use the **F4 (▶)** button to advance to that sub-screen.
- On a sub-screen, press the **F1 (BACK)** button to return to the previous screen.

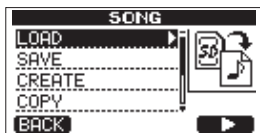

- To execute an item, press the function button with the "EXEC" assignment.

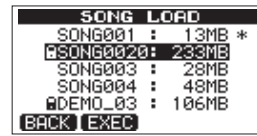

In this example of the **SONG LOAD** screen, if you press the **F2 (EXEC)** button the song that is selected by the cursor will be loaded.

- When the cursor is on a setting value, use the **DATA** wheel to change the value. Use the function buttons with **▲** and **▼** assignments to move the cursor.



In this example of the **COPY PASTE** screen, you can use the **DATA** wheel to change the value of the **SOURCE TRK**. Use the **F3 (▲)** and **F4 (▼)** buttons to move the cursor up and down. Press the **F2 (EXEC)** button to copy and paste the contents shown.

- When it is necessary to move left and right, use the **REW (◀◀) (TO ZERO)** and **F FWD (▶▶) (TO LAST REC)** buttons. At such times, an illustration appears on the screen showing that the **REW (◀◀)** and **F FWD (▶▶)** buttons are assigned to control the **CURSOR**.



- Press the **HOME** button to return to the Home Screen.

4 – Preparations

Preparing the power and the SD card

Installing an SD card

- 1 Open the SD card slot cover on the left side panel of the unit.
- 2 Insert the SD Card into the slot as shown in the illustration until it clicks into place.

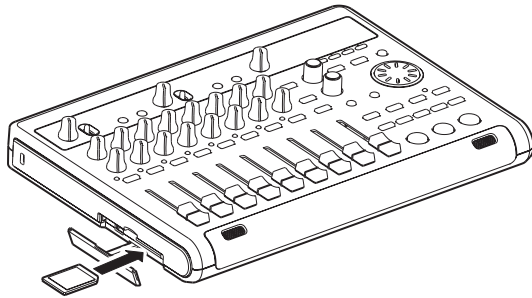

- 3 After inserting the card, close the cover.

NOTE

An SD card is installed in the card slot when the unit is shipped from the factory. You can use this card as is to record and play back files. There is no need to reinsert it.

Ejecting the card

Push and insert the card further in to eject it.

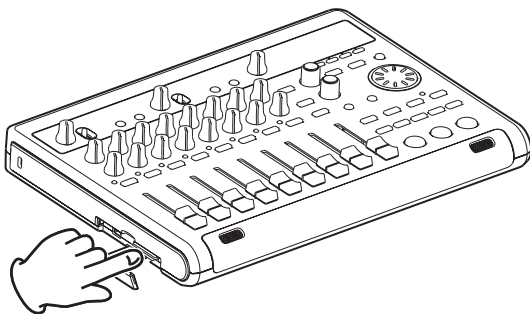

CAUTION

- Always turn the power OFF before removing an SD card. Removing a card while the power is still ON will cause any recordings and settings made since the last time the power was turned OFF or the song was saved to be lost. These data and settings cannot be recovered.
- This unit uses SD cards for recording and playback. SD and SDHC cards that are at least 512 MB in size can be used.
- A list of SD cards that have been confirmed for use with this unit can be found on our web site. Please access to a product page of this product from the TEAC Global Site (<http://teac-global.com>) to find the list or contact the TASCAM customer support service.

Write-protected cards

SD cards have write-protect (lock) switches.

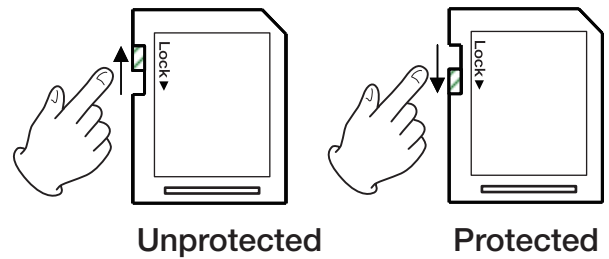

When the protect switch is in the LOCK position, files cannot be recorded or edited on the card. Slide the switch away from the LOCK position if you want to record, erase or otherwise change files on a card.

Preparing the power

As shown in the illustration, connect the included PS-1225L AC adaptor to the DC IN 12V jack.

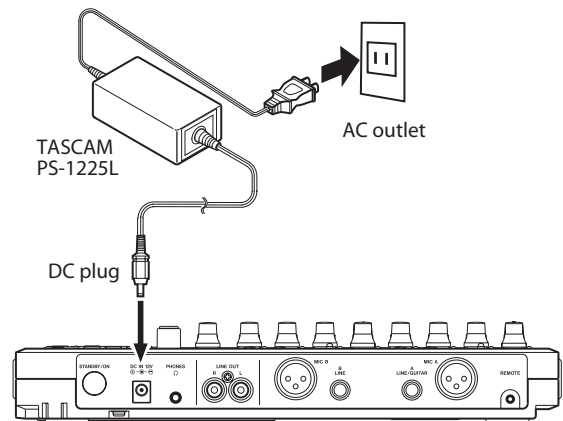

The bottom panel has a hook (cord holder) that can be used to hold the AC adaptor cord in place.

When using it, wrap the cord around this cord holder to prevent it from being disconnected during use.

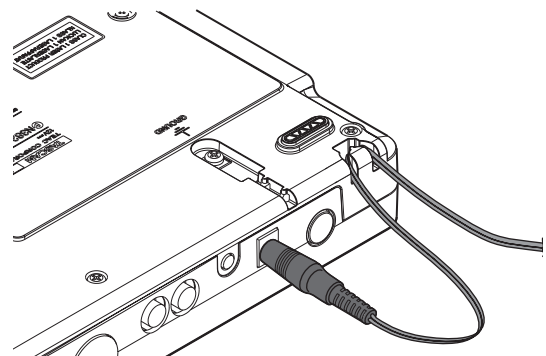

CAUTION

- Use only the TASCAM PS-1225L AC adaptor and power cord. Using an AC adaptor other than this one could cause malfunction, fire or electric shock.
- The AC adaptor must be used to supply power to this unit. Power cannot be supplied to this unit by USB.

Startup & shutdown

Starting up the unit

Press the **STANDBY/ON** button on the rear panel.

When the unit starts, the startup screen will appear followed by the Home Screen, as shown below.

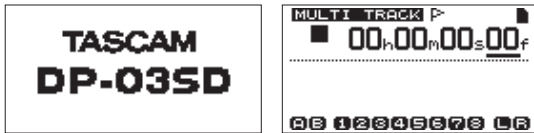

Startup Screen

Home Screen

When the unit starts up it defaults to **MULTITRACK** recorder mode regardless of the mode used last before shutting down.

CAUTION

When turning the unit's power ON and OFF (STANDBY), turn down the volume of any speakers or amplifiers connected to the unit. Moreover, do not wear headphones connected to the unit when switching the power ON or OFF (STANDBY). This will avoid damage to speakers and possible harm to your hearing from noise that might occur.

Shutting down

Make the following preparations before shutting down the unit.

- Stop the recorder. (The unit cannot be shut down during playback, recording, searching forward, etc.)
- Return to the Home Screen.
- If the unit is connected to a computer, disconnect the USB cable after conducting the necessary procedures on the computer to unmount the unit.

After making these preparations, press and hold the **STANDBY/ON** button on the rear panel until the following screen appears.



The power turns OFF (STANDBY) after the unit completes its shutdown process, including saving various information from your session.

CAUTION

- *Do not disconnect the power cord or otherwise cut the power supply when the power is ON. If you do so, all recorded data and settings made since the last time the unit was shut down or a song was saved will be lost. These lost data and settings cannot be recovered.*
- *When the power is turned OFF (STANDBY), the operation history of the currently loaded song will be erased (cleared). When you turn the power back ON, the song will be restored to the previous state, but you will not be able to undo or redo operations on the song.*

Formatting SD cards

To use a new SD card with this unit, it is necessary to format it first. SD cards formatted by the unit are divided into FAT partitions and MTR partitions.

For more information about partitions see "11 – SD Card Management" on page 57.

CAUTION

If you format a card, all data saved on it by this or any other device will be erased and you will not be able to recover it.

NOTE

The included SD card is already formatted so formatting it is not necessary. If you format this card the demo song on it will be erased.

- 1 The first time you put a new SD card in this unit, a message prompting you to format it appears.



NOTE

The message shown above prompting you to format it also appears if you put in an SD card that has been formatted by any device other than this unit.

- 2 Press the **F3** (YES) button.
- 3 The Home Screen appears after formatting completes properly.

NOTE

*To cancel formatting press the **F4** (NO) key instead in step 2 above.*

4 – Preparations

Recorder modes

This unit has four recorder modes.

MULTITRACK

Use to operate the unit as a multitrack recorder.

BOUNCE

Use to bounce tracks. (See “Bouncing tracks” on page 39.)

MIXDOWN

Use to mix down tracks to create a stereo master track. (See “Mixing down tracks” on page 48 and “Creating a stereo master track” on page 49.)

MASTERING

Use to play stereo master tracks that you have created and apply effects to them (mastering). (See “Checking the stereo master track” on page 51 and “Mastering the stereo master track” on page 51.)

When the unit’s power is turned ON, it always starts up in **MULTITRACK** mode.

When in any mode besides **MULTITRACK** mode, many of the usual operations using the screen are unavailable.

In this Owner’s Manual, the **MULTITRACK** mode is the recorder mode explained unless otherwise noted.

Connecting other equipment

This section shows examples of connecting other equipment with this unit.

■ Precautions before making connections

- Turn the power of this unit and all devices that you will connect with it OFF (or put them in standby power mode) beforehand.
- Supply power to all the devices from the same line. When using a power strip, for example, use one with a cable that has a high electric current capacity in order to minimize power voltage variations.

Rear panel

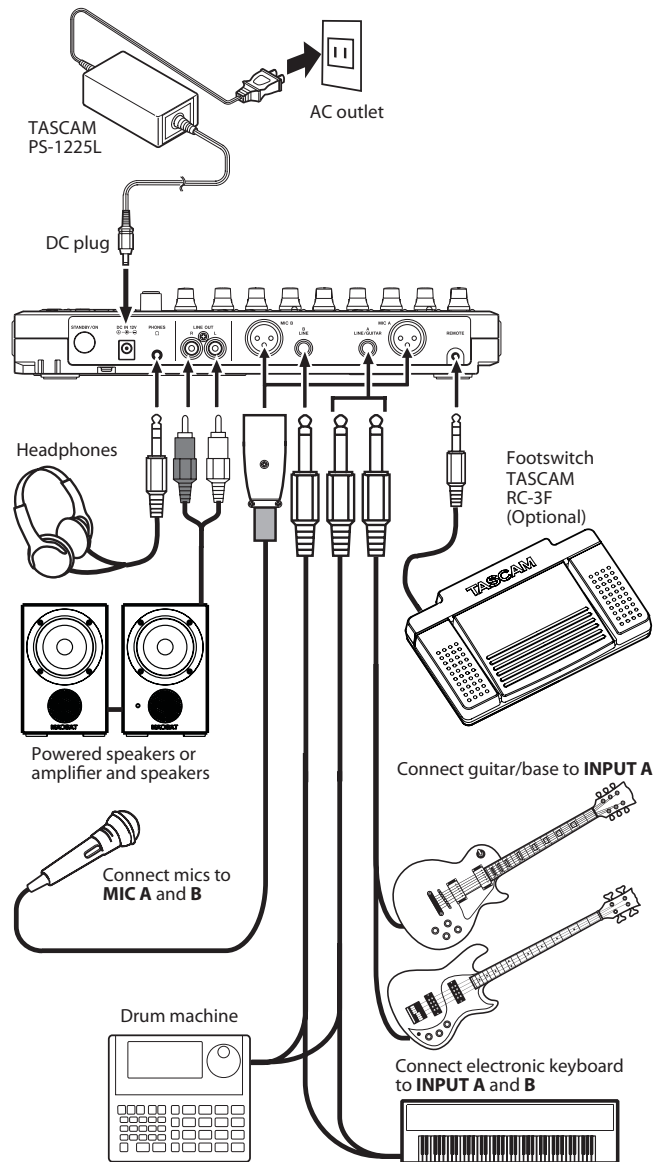

CAUTION

- Do not input signals into both the XLR and standard jacks at the same time.
- Do not connect a dynamic microphone using an unbalanced connection when phantom power is ON. Doing so could break it.
- Do not connect or disconnect a mic when phantom power is ON. This could cause a loud noise and damage equipment.
- Turn the unit output volume down using the **PHONES** knob and **MASTER** fader on the front panel before turning phantom power ON or OFF. Depending on the mic, a loud noise could occur, damaging equipment and harming people’s hearing.

Left side panel

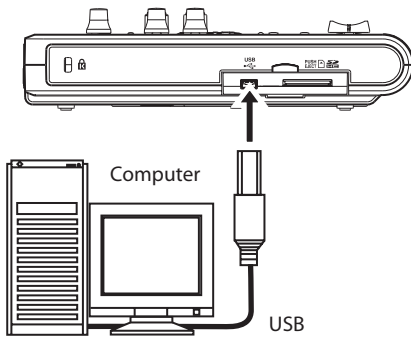

NOTE

Recorder functions cannot be used when the unit is connected to a computer by USB.

Adjusting the contrast

The contrast of the display can be adjusted.

Follow the procedures below to adjust the contrast.

- 1 When the recorder is stopped, press the **MENU** button to open the MENU screen.
- 2 Use the data wheel to select **PREFERENCE**, and press the **F4 (▶)** button to open the **PREFERENCE** screen.

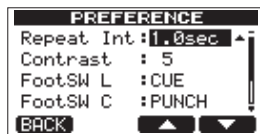

- 3 Use the **F3 (▲)** and **F4 (▼)** buttons to select the Contrast setting value, and use the **DATA** wheel to adjust the display contrast.

The setting range is from 1-10.

The default value is 5.

Lower values reduce the display contrast while higher values increase it.

Adjusting the contrast might make the display easier to read. Its appearance differs depending on the angle from which it is viewed, so adjust the contrast while the unit is in the actual position in which it will be used.

- 4 After making the setting, press the **HOME** button to return to the Home Screen.

5 – Song Management

This unit manages data in units called “songs”. Ordinarily, each project should have its own “song” file. The first step is to load the song that you want to manage (load an existing song or create a new song).

In a song, the audio data for the recorded multitrack (tracks 1–8) and the stereo master track are saved.

This chapter starts with an explanation of SD card partitions, and then covers basic operations, including procedures for loading songs and creating new songs, as well as various song management functions.

Partitions and songs

This unit uses SD cards to record songs. SD cards formatted by the unit are divided into partitions.

The partitions include MTR partitions for recording song data and FAT partitions that can be read and written to by computers.

Editing names

You can edit names on the following screens.

- When creating, saving or editing the name of a song (SAVE, CREATE and NAME EDIT)
- When exporting a WAV file (NAME EDIT and EXPORT MASTER)
- When backing up a song (SONG BACKUP)



SONG CREATE name editing screen

Use the following controls to edit names.

- Use the **REW** (◀◀) (TO ZERO) and **F FWD** (▶▶) (TO LAST REC) buttons to move the cursor (underline) position. The character at the cursor position is the one that can be edited.
- Use the **DATA** wheel to change the characters at the cursor (underline) position. Ordinary symbols, numerals and English upper and lower case letters can be input.
- To insert a blank at the cursor position, press the **F3** (INS) button. When editing a file name, an “A” is inserted at the blank space.
- Press the **F4** (DEL) button to delete the character at the cursor position.
- When you have finished inputting and editing, press the **F2** (EXEC) button to save the edited name.

Loading a saved song

Follow these procedures to load the song you want.

- 1 When the recorder is stopped, press the **MENU** button to open the MENU screen.
- 2 Use the data wheel to select **SONG**, and press the **F4** (▶) button to open the SONG screen.
- 3 Use the **DATA** wheel to select **LOAD**, and press the **F4** (▶) button to open the SONG LOAD screen, which shows a list of songs in the current partition. A star (*) icon appears

to the right of the currently loaded song. A lock (🔒) icon appears to the left of songs that are protected.

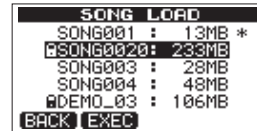
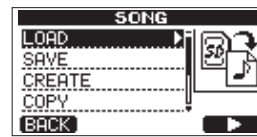

- 4 Use the **DATA** wheel to select the song you want, and press the **F2** (EXEC) button. The currently loaded song is saved and the selected song is loaded.
- 5 Press the **HOME** button to return to the Home Screen.

Creating a new song

Follow these procedures to create a new song.

- 1 When the recorder is stopped, press the **MENU** button to open the MENU screen.
- 2 Use the **DATA** wheel to select **SONG**, and press the **F4** (▶) button to open the SONG screen.
- 3 Use the **DATA** wheel to select **CREATE**, and press the **F4** (▶) button to open the SONG CREATE screen.

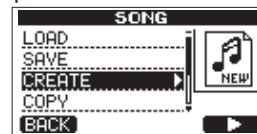

A default song name like “SONG*****” is given to the new song. (***** indicates a number. In the example above the name is “SONG0020”)

- 4 Change the song name (title) as necessary. (See “Editing names” on page 30 for how to do this.)

TIP

You can edit the name of a song later by selecting NAME EDIT from the SONG screen. You can also edit the song name when saving the song.

- 5 Press the **F2** (EXEC) button to save the currently loaded song and create the new song.
- 6 Press the **HOME** button to return to the Home Screen.

Saving a song

This unit automatically saves the current song during shutdown and when loading another song. You can also save a song at any time using the following procedures.

- 1 When the recorder is stopped, press the **MENU** button to open the MENU screen.

5 – Song Management

- Use the **DATA** wheel to select **SONG**, and press the **F4** (▶) button to open the **SONG** screen.
- Use the **DATA** wheel to select **SAVE**, and press the **F4** (▶) button to open the **SONG SAVE** screen.

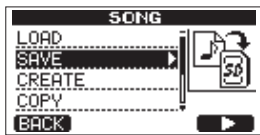

- Change the song name (title) if you want, and then press the **F2** (EXEC) button (see “Editing names” on page 30). To save without changing the name, just press the **F2** (EXEC) button.
- Press the **HOME** button to return to the Home Screen.

Viewing song information

You can check the name, partition and remaining recording time of the currently loaded song.

- Press the **MENU** button to open the **MENU** screen.
- Use the **DATA** wheel to select **INFORMATION**, and press the **F4** (▶) button to open the **SONG (1/3)** page of the **INFORMATION** screen, which shows the name and remaining recording time of the current song.

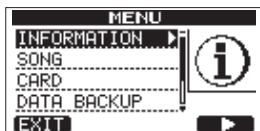

NOTE

The **INFORMATION** screen has three pages, including **SONG (1/3)**, **CARD (2/3)** and **F/W (3/3)**. Use the **F3** (PREV) and **F4** (NEXT) buttons to change the page (see “Viewing information” on page 56).

Copying songs

You can copy a single song or multiple songs at once. You can make a copy of a song in the same partition if you want to save a certain mix, for example.

- When the recorder is stopped, press the **MENU** button to open the **MENU** screen.
- Use the **DATA** wheel to select **SONG**, and press the **F4** (▶) button to open the **SONG** screen.
- Use the **DATA** wheel to select **COPY**, and press the **F4** (▶) button to open the **SONG COPY** screen, which shows a list of songs.



- Use the **DATA** wheel to select a song that you want to copy, and press the **F4** (✓) button. The song is selected as a copy source and a check appears in the checkbox.



NOTE

To remove a check from the checkbox, press the **F4** (✓) button while the song is selected.

- To copy multiple songs, repeat step 4.
- After selecting all the songs that you want to copy, press the **F2** (NEXT) button to open a screen where you can select the MTR partition that you want to be the copy destination.



This screen also shows the amount of open space on the partition selected (**Free**) and the size of the data of the song being copied (**Total**). If the open space is smaller than the size of the song, copying is not possible and a **No Disk Space** warning appears.

NOTE

An SD card formatted by this unit can only have one partition, so it is not usually possible to copy to a different partition. However, this unit can use an SD card that has been created with multiple partitions on another TASCAM DP series unit, and copying between partitions is possible in this case.

- Press the **F4** (EXEC) button to copy the file(s) and return to the **SONG** screen.

NOTE

To cancel song copying, press the **F1** (BACK) button instead of the **F4** (EXEC) button.

- Press the **HOME** button to return to the Home Screen.

Erasing songs

You can erase a single song or multiple songs at once. You might want to erase unneeded songs if the SD card starts to run out of open space.

- When the recorder is stopped, press the **MENU** button to open the **MENU** screen.

5 – Song Management

- Use the **DATA** wheel to select **SONG**, and press the **F4 (▶)** button to open the **SONG** screen.
- Use the **DATA** wheel to select **ERASE**, and press the **F4 (▶)** button to open the **SONG ERASE** screen, which shows a list of songs.

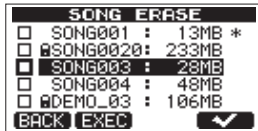
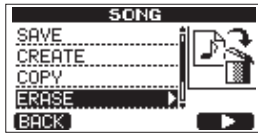

- Use the **DATA** wheel to select a song that you want to erase and press the **F4 (✓)** button. A check appears in the checkbox next to the song.

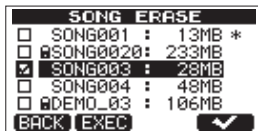

NOTE

To remove the check from the checkbox, press the **F4 (✓)** while the song is selected.

- To erase multiple songs, repeat step 4.
- After selecting all songs that you want to erase, press the **F2 (EXEC)** button. A confirmation screen opens.

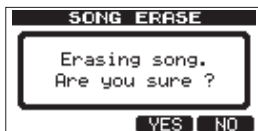

- Press the **F3 (YES)** button. After the songs are erased, the **SONG** screen reopens.

NOTE

To cancel erasing a song, press the **F4 (NO)** button instead of **F3 (YES)** button.

- Press the **HOME** button to return to the Home Screen.

NOTE

Every MTR partition must always have at least one song, so if you erase all the songs on a partition, a new song is created automatically.

Protecting songs

If you protect a song, editing, recording and erasing of that song is prevented.

- Load the song that you want to protect.
- When the recorder is stopped, press the **MENU** button to open the **MENU** screen.
- Use the **DATA** wheel to select **SONG**, and press the **F4 (▶)** button to open the **SONG** screen.
- Use the **DATA** wheel to select **PROTECT**, and press the **F4 (▶)** button to open the **SONG PROTECT** screen, where you can turn protection ON and OFF.



- Use the **DATA** wheel to set **PROTECT** to **ON**, and press the **F2 (EXEC)** button. After **PROTECT** is turned **ON**, the **SONG** screen reopens.
- Press the **HOME** button to return to the Home Screen.

NOTE

- In the song list used to copy, erase and conduct other functions, a lock icon (🔒) appears next to protected songs.
- If you try to execute a prohibited operation (edit, record, erase) on a protected song, a "Song Protected" message appears and the operation is prevented.
- To remove protection from a song, follow the above procedures but set **PROTECT** to **OFF** in step 4.

6 – Basic Recording

Selecting the input sources

This unit has two inputs (**INPUT A** and **INPUT B**) that can be selected separately as input sources.

The input sources that can be selected with the **INPUT A** and **INPUT B** switches include the built-in mics (**MIC A** and **MIC B**) on the front panel or connected devices input through **INPUT A** and **INPUT B** on the rear panel. In addition to mic and line signals, the **INPUT A** standard jack can accept guitar input. Set the **INPUT A** switch to **GUITAR** to input a guitar.

	INPUT A	INPUT B
GUITAR	Use when connecting a guitar or bass directly to the standard INPUT A jack	—
MIC/LINE	INPUT A jack (XLR or standard jack)	INPUT B jack (XLR or standard jack)
INTERNAL MIC A/B	Built-in mic (MIC A)	Built-in mic (MIC B)

NOTE

Do not connect to both the XLR connector and the standard jack of an input (**INPUT A** or **INPUT B**) at the same time.

TIP

When connecting an electric-acoustic guitar with a built-in preamp or an active electric guitar, as well as when connecting an electric guitar with an effect pedal between it and this unit, set the **INPUT A** switch to **MIC/LINE**.

Using phantom power

When connecting a condenser microphone that requires phantom power, follow the procedures below to turn phantom power ON. When phantom power is ON, phantom power is provided to the XLR jacks of both **INPUT A** and **INPUT B**.

- 1 When the recorder is stopped, press the **PHANTOM** button to open the **PHANTOM** screen.

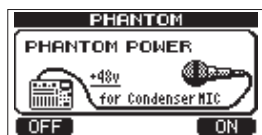
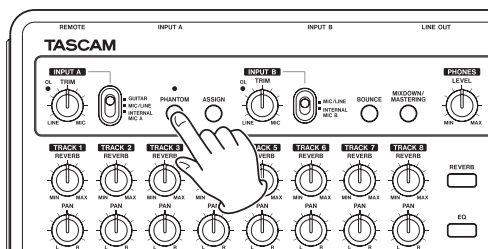

- 2 Press the **F4** (**ON**) button to turn phantom power ON. The indicator above the **PHANTOM** button lights, and the Home Screen reopens.

To turn phantom power OFF, press the **F1** (**OFF**) button instead.

The following screen appears whenever phantom power is being turned ON or OFF.



NOTE

The screen above appears when phantom power is being turned ON or OFF. No other operations can be conducted while this message is shown. Other operations will be possible after this message disappears and the Home Screen reopens.

CAUTION

- Turn the master fader down before turning phantom power ON or OFF. Depending on the mic, a loud noise could occur, damaging equipment and harming people's hearing.
- Do not connect or disconnect a mic when phantom power is ON. This could cause a loud noise and damage equipment.
- Turn phantom power ON only when using a condenser microphone that requires phantom power.
- Do not supply phantom power to an unbalanced dynamic microphone. Doing so could break it.
- Supplying phantom power to some types of ribbon microphones could break them. Do not supply phantom power to a ribbon microphone if you are in doubt.

Monitoring input signals

To monitor an input signal press the **REC** button for the track set to record that signal. That track's **REC** indicator will light/blink.

NOTE

When the unit is playing back, both the playback signal and the input source signals are mixed and output through the **PHONES** and **LINE OUT** jacks and can be heard with connected headphones and monitoring systems.

6 – Basic Recording

OL indicators and level meters

The audio levels of this unit can be checked using the **INPUT A** and **INPUT B** OL indicators and the level meters shown on the display.

The level meters allow the signal levels to be monitored, and they can also be used to confirm whether signals are being input into the unit. For example, if the A and B level meters are moving a signal is being input into the unit even if you cannot hear anything when monitoring.

As shown below, if a “-” appears at the top of a level meter, the level is too high (when a “-” appears, it will stay on screen for a while before automatically disappearing). If the level is too loud, the sound might be distorted, so lower the level until the “-” stops appearing.

If an **OL** indicator lights, the signal from the input source could be too loud or the **TRIM** knob set too high.

If the **OL** indicator lights even though the **TRIM** knob is set to the minimum position, the input source signal is too strong. Lower the volume on the input source.

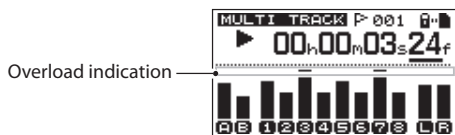

Input level meters (A, B)

The and level meters on the left side of the display show the input levels of **INPUT A** and **INPUT B**.

Use the **INPUT A** and **INPUT B** **TRIM** knobs and the output volumes of the input sources to adjust the level.

Track level meters (1–8)

These level meters show either the playback signal levels or the input signal levels of the corresponding tracks.

The signal levels shown by the track level meters depend on the operating conditions as shown below.

REC indicator	Transport status	Level meter display contents
Unlit	Playback	Track playback signal
Blinks (record standby)	Playback	Track playback signal
Blinks (record standby)	Stopped	Track input signal
Lit (during recording)	Recording	Track input signal

NOTE

When the playback signal is being shown, the level of the recorded signal of the track is shown, so the levels shown by the meters cannot be changed.

*When the input signal is being shown, the levels shown by the meters can be changed using the **TRIM** knobs for **INPUT A** and **INPUT B**.*

Stereo level meter (L, R)

These show the stereo bus output level of this unit. Adjust the output level with the **MASTER** fader.

Assigning inputs

When using this unit, “assigning inputs” means setting the recording source for each track to either **INPUT A** or **INPUT B**.

This unit can simultaneously record a maximum of two tracks. You can also record one input to two tracks simultaneously (in this case, you cannot use the other input). You cannot assign two inputs to the same track.

- 1 When the recorder is stopped, press the **ASSIGN** button to open the **INPUT ASSIGN** screen.

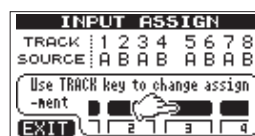

By default, **A (INPUT A)** is assigned as the recording source for tracks 1, 3, 5 and 7, and **B (INPUT B)** is assigned as the recording source for tracks 2, 4, 6 and 8.

- 2 Use the **REC** button to set the input source for each track to either **A (INPUT A)** or **B (INPUT B)**.

Each time you press the **REC** button the setting switches between **A** and **B**.

- 3 After making the settings, press the **HOME** button to return to the Home Screen.

Using input EQ (equalizer)

INPUT A and **INPUT B** each have a two-band equalizer (EQ).

Use the **INPUT EQ** screen to make input EQ settings.

- 1 Press the **EQ** button to open the **EQ SETTING** screen.

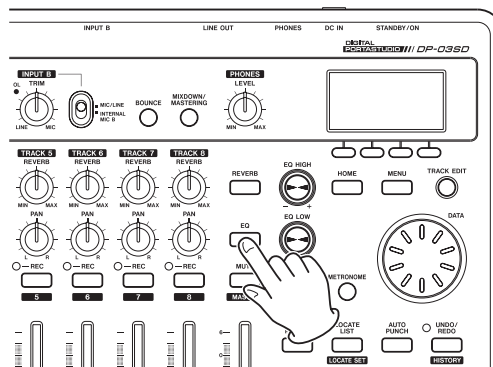

This shows the setting screen for track one (TR1).

- 2 Press the **F1 (INPUT)** button to open the **INPUT EQ** screen. This shows the setting screen for **IN A**.

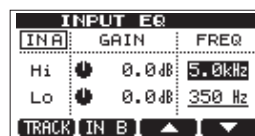

The equalizer parameters are as follows.

	GAIN	FREQ
Hi	High-frequency gain Setting range: ±12 dB (Default value: 0.0 dB)	High-frequency value Setting range: 1.7–18 kHz (Default value: 5 kHz)
Lo	Low-frequency gain Setting range: ±12 dB (Default value: 0.0 dB)	Low-frequency value Setting range: 32 Hz–1.6 kHz (Default value: 350 Hz)

Use the **F2 (IN B)** (or **(IN A)**) button to switch between **INPUT A** and **INPUT B**.

Use the **EQ HIGH** knob to adjust the **Hi** gain and the **EQ LOW** knob to adjust the **Lo** gain.

Use the **F3 (▲)** and **F4 (▼)** button to select **Hi** or **Lo**, and use the **DATA** wheel to set the **FREQ** value.

Press the **F1 (TRACK)** button to return to the **EQ SETTING** screen.

- 3 After making the setting, press the **HOME** button to return to the Home Screen.

NOTE

When input EQ is ON for an input, the input is shown on the Home Screen as in the illustration below.

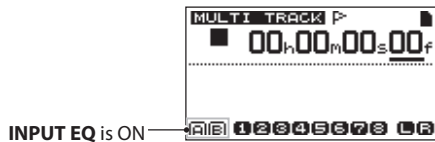

Making the first recording

Before beginning the following recording procedures, connect a recording source to an input, assign that input as the recording source for a track, and prepare your monitors (headphones).

- 1 Press the **REC** button of the track that you want to record on. The **REC** indicator blinks red (this status is called “record standby”).

A maximum of two tracks can be recorded simultaneously. If you press a different **REC** button when two track **REC** indicators are already blinking, the track that was put into record standby first will become inactive and its **REC** indicator will become unlit.

For example, if you press the **REC** buttons for TRACK 1, TRACK 2 and TRACK 3 in that order, TRACK 1, which was pressed first, will no longer be in record standby, but TRACK 2 and TRACK 3, which were pressed afterwards, will still be in record standby.

- 2 Set the recording level.

Use the **INPUT A** or **INPUT B TRIM** knob to adjust the input level. Watch the A or B level meter on the display and the **OL** indicator above and to the left of the **TRIM** knob while setting the level suitably.

At the same time, confirm that sound heard from the headphones or the monitoring system is not distorted.

NOTE

- *The level meter of the track that has an input signal assigned to it shows the input level after the application of*

input EQ. Therefore, when using input EQ, you should also watch the level meter of the track that has the affected input signal assigned to it.

- *The **OL** indicator lights if the input is too loud.*
 - *If the **OL** indicator stays lit even when you lower the **TRIM** knob for that input, lower the input source signal level.*
- 3 Press and hold the **RECORD (●)** button and press the **PLAY (▶)** button to start recording. The **RECORD (●)** button lights red and the track **REC** indicator stops blinking and stays lit.
 - 4 Press the **STOP (■)** button to stop recording. If you want to check a part of the recording, use the **REW (◀◀)** (**TO ZERO**) button, for example, to locate to it.

TIP

*Use the **TO LAST REC** function to locate to the last position that recording started and the **TO ZERO** function to return to the start of the song (00:00:00), for example, to move through a recording easily. For information about the forward and backward search functions, see “Locate and search functions” on page 39.*

- 5 Press the **PLAY (▶)** button to play back the recorded track. Use the track faders and **MASTER** fader to adjust the playback level. Adjust the **PHONES LEVEL** knob or the volume control on your monitoring system to set the final monitoring volume. Use the **PAN** knobs to set the stereo position of each track between the left and right speakers.

NOTE

*The track **PAN** knobs and level faders control that recorded track’s playback output signal or the monitored input signal. They do not control the signal being recorded to the track.*

If you are not satisfied with the recorded sound, follow the procedures above again from the beginning.

Multitrack recording

You can record new sounds to different tracks while playing back already recorded tracks.

Prepare tracks for recording

- 1 Press the **REC** buttons of the already recorded tracks to disarm recording to them (**REC** indicators OFF).
- 2 Press the **REC** buttons of the tracks that you want to record to put them into record standby (**REC** indicators blinking).

Track pan and level settings

Use the track faders and **PAN** knobs of the already recorded tracks to adjust their levels and stereo positions for monitoring their playback signals while making new recordings.

Input selection and assignment

Use the procedures described earlier in this chapter to assign input sources to tracks for recording.

6 – Basic Recording

Setting input levels

After making the above settings, press the **PLAY** (▶) button to start playback.

Just as though you were recording, you can monitor the sound of already recorded tracks playing back and the input sources on the tracks for recording, allowing you to check the monitoring balance and volume. Adjust the input levels suitably as you monitor both playback and input signals.

Record additional tracks

Press and hold the **RECORD** (●) button and press the **PLAY** (▶) button to start the new recordings to the other tracks while monitoring the playback signal

Undoing an operation

This unit allows you to undo an operation or recording that did not work as planned or was otherwise unsatisfactory. Undo can be used on many ordinary operations, including editing and recording operations.

This unit has two types of undo functions. Single undo can be used with a simple button press, while multi-undo allows you to return to a specific past operation and undo the operations that occurred after it.

NOTE

*The **UNDO/REDO** indicator lights when a single undo or multi-undo has been conducted*

Undoing the last operation (single undo)

Press the **UNDO/REDO [HISTORY]** button to return to the state before the last operation was conducted. After doing this, the **UNDO/REDO** indicator lights, showing that redo (see below) is possible.

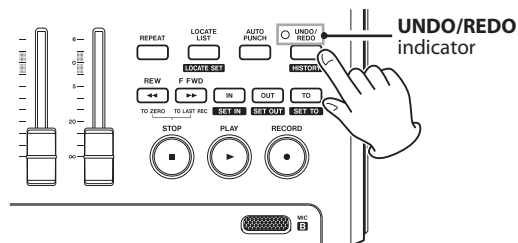

Cancelling an undo operation (redo)

Press the **UNDO/REDO [HISTORY]** buttons when its indicator is lit to return to the state of the last operation. The **UNDO/REDO** indicator becomes unlit.

NOTE

If single undo is used when multi-undo (described below) has already been used to return the unit to a previous state, it will go one more step backward.

*If you press the **UNDO/REDO [HISTORY]** button again to redo, the single undo operation is cancelled, and the previous multi-undo state is restored. In this case, the operations undone by multi-undo are still retained in history, so the **UNDO/REDO** indicator stays lit.*

Undoing a previous operation (multi-undo)

- 1 Press and hold the **UNDO/REDO [HISTORY]** button to open the **HISTORY** screen.



This screen shows the operation history as a list. Each operation in the list is called an “event.”

The event list starts at the bottom with event number “0” (–START UP–) and proceeds up to the most recent event at the top, which has a * next to it.

All events in this list that occurred after a selected event can be undone at once. This operation is called “multi-undo” because it allows you to undo multiple events and return to an earlier state.

- 2 Use the **DATA** wheel to select the event that you want to return to (all events after the selected event will be undone).

- Press the **F2 (EXEC)** button to execute the multi-undo and restore the song state to just after the selected event was conducted. In this state, the **UNDO/REDO** indicator lights. The event information undone through the above operation is not erased. The unit has simply been returned to a previous state. On the **HISTORY** screen, a * appears next to the most recent event after undoing.

NOTE

*When the **HISTORY** screen is open, the **UNDO/REDO [HISTORY]** button does not function, so single undo and redo cannot be used.*

CAUTION

- When saving a song, a maximum of 500 operation history items can be saved with the song data. If the operation history exceeds 500 items, the oldest events in the history are erased when the song is saved. These erased events cannot be restored.
- When the power is turned OFF (STANDBY) the operation history is completely erased. The operation history is not restored when the power is turned ON again.

Erasing the operation history

When the power is turned OFF (STANDBY), the operation history of the currently loaded song is erased (cleared).

When the power is turned ON again, the song last in use is reloaded in the same state it was in when the power was turned OFF (STANDBY). The operation history is not restored, however, so past operations cannot be undone or redone.

NOTE

The operation histories of songs that are not loaded are not erased when the power is turned OFF (STANDBY).

Using the following procedures, you can also erase (clear) the operation history of the currently loaded song without turning the power OFF.

- Press and hold the **UNDO/REDO [HISTORY]** button to open the **HISTORY** screen.



- Press the **F4 (CLEAR)** button. A confirmation message appears.



- Press the **F3 (YES)** button. Another confirmation message appears again.



- Press the **F3 (YES)** button to clear the operation history and erase the unused data. The Home Screen reopens when this operation completes.

NOTE

*To cancel erasing the operation history, press the **F4 (NO)** button.*

TIP

- If you open the **HISTORY** screen immediately after erasing the operation history, the event (operation) that appears is "0" (-START UP-), confirming that all operation history has been cleared.
- If you want to keep the operation history even when you power OFF (STANDBY), turn song protect ON before turning the power OFF (STANDBY) (see "Protecting songs" on page 32).

CAUTION

You cannot undo erasing the operation history! Only erase it when you are certain that you want to do so.

7 – Recorder Functions

Punching in and out

Punching in/out is a technique to replace a part of an already recorded track.

Start playback and when you reach the part that you want to replace, switch to record (punch in), then switch back to playback (or stop) when you finish the part that you want to replace (punch out).

- 1 Decide what part of the track you plan to replace and choose a point to begin where the new recording can sit well with the existing recording.
- 2 Press the **REC** button of the track that you plan to replace part of to start record standby (**REC** indicator blinks).
- 3 Start playback before the part of the track that you want to replace.
- 4 Press the **RECORD** (●) button to start recording (punch in) when you reach the part. Play or sing what you want to record.
- 5 Press the **PLAY** (▶) button to switch to playback (punch out) when you finish the replacement recording.

NOTE

When the recording source is set to a built-in microphone (INTERNAL MIC A/B), the sound of pressing a button to punch in and out could be recorded. This can be avoided by using a foot switch to punch in and out or the automatic punching in and out functions. (See “Automatically punching in and out” on page 43.)

TIP

*You can also press the **STOP** (■) key to punch out at the end of the replacement recording.*

Using the foot switch to punch in/out

Using a foot switch connected to the **REMOTE** jack on the rear panel, you can punch in and out.

In step 4 above, step on the foot switch instead of pressing the **RECORD** (●) button. In step 5, step on the foot switch again instead of pressing the **PLAY** (▶) button.

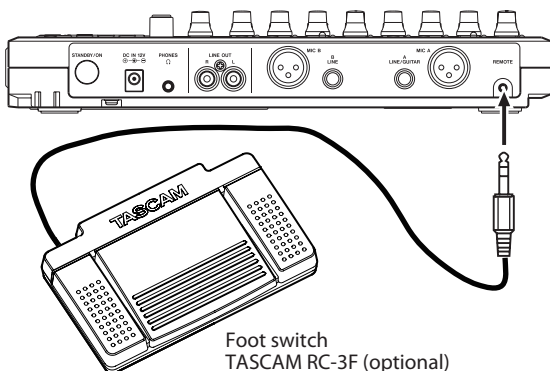

Foot switch
TASCAM RC-3F (optional)

NOTE

*Press the switch (pedal) that you have set to **PUNCH** in the foot switch settings. By default, the center pedal (Foot SW C) is set to **PUNCH**. (See “Setting the foot switch” on page 38.)*

Setting the foot switch

Set the foot switch on the **PREFERENCE** screen.

- 1 When the recorder is stopped, press the **MENU** button to open the **MENU** screen.
- 2 Use the **DATA** wheel to select **PREFERENCE**, and press the **F4** (▶) button to open the **PREFERENCE** screen.
- 3 Use the **F3** (▲) and **F4** (▼) buttons to select **FootSW L**.

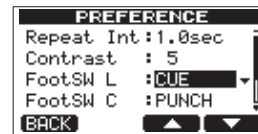

- 4 Use the **DATA** wheel to select the function to assign to the left foot switch pedal.
- 5 In the same way, use the **Foot SW C** item to set the function of the center pedal and the **Foot SW R** item to set the function of the right pedal.
- 6 After making the settings, press the **HOME** button to return to the Home Screen.

Setting	Function
PLAY	Same as the unit's PLAY (▶) button
REC	Same as the unit's RECORD (●) button
STOP	Same as the unit's STOP (■) button
F FWD	Same as the unit's F FWD (▶▶) (TO LAST REC) button
REW	Same as the unit's REW (◀◀) (TO ZERO) button
PUNCH	Press during playback to PUNCH IN and during recording to PUNCH OUT
PLY/STP	Press when stopped to start playback, and press at any other time to stop
CUE	Locate to the last point where playback started

Default values: **CUE** (L), **PUNCH** (C), **PLY/STP** (R)

Bouncing tracks

Use this unit's bounce function to mix already recorded tracks (1–8) down to one or two tracks.

Multitrack tape recorders can only bounce to an open track (in other words, they can not record to a track that is also a source of the mix). For example, tracks 1–7 could be bounced to track 8, but tracks 1–8 could not be bounced to track 1. This unit, however, does not have this limitation. You can bounce tracks 1–8 to mix down to tracks 1 and 2 (stereo bounce), or bounce tracks 1–8 as a mono mix to track 1 (mono bounce).

NOTE

Inside this unit, a mixdown is made to create a mix master that is recorded to the designated tracks.

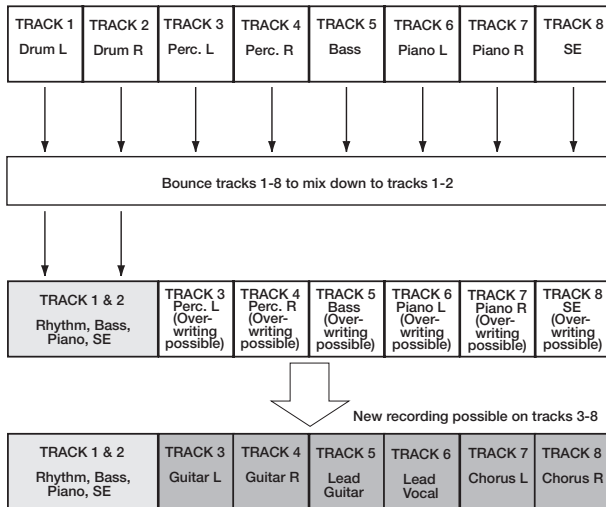

Source tracks are erased when they are bounce destinations. (In the illustration above the drum parts are overwritten by the stereo mix). However, you can use the unit's (undo) function to return to the previous state if you make a mistake (see "Undoing the last operation (single undo)" on page 36).

Using the bounce function

- 1 In multitrack mode, press the **BOUNCE** button.

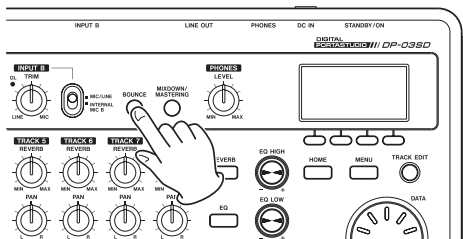

After the **Bounce** ! pop-up message appears, the unit switches to BOUNCE mode and the Home Screen reopens.



- 2 Press the **REC** buttons for the bounce destination tracks (the indicators blink).

For a stereo bounce, press the **REC** buttons for any two tracks. For a mono bounce (bouncing the mix to a single track) press the **REC** button for any one track.

- 3 Adjust the track faders and PAN knobs for the bounce source tracks.

When making a stereo bounce, the lower numbered track is the left (L) side.

For a mono bounce, turn the PAN knobs of the bounce source tracks all the way to L.

Use the **MASTER** fader to adjust the overall level.

- 4 After returning to the start of the song, press the **PLAY** (▶) button while pressing and holding the **RECORD** (●) button to start the bounce.

Confirming the result

Mute the bounce source tracks (see "Muting tracks" on page 49), and play the song from the beginning.

If you are not satisfied with the result because, for example, the balance between instruments is poor, or the pan settings are wrong, use the undo function (see "Undoing the last operation (single undo)" on page 36).

If you are satisfied with the result, press the **BOUNCE** button to return to the **MULTI TRACK** mode.

After bouncing tracks, you can make new recordings over the other tracks.

TIP

If it is possible that you might need the original tracks at some later time, back-up the track data to a computer or copy the song before bouncing (see "Backing-up songs" on page 61 and "Connecting with a computer" on page 60).

Locate and search functions

Direct locate function

The current recorder position is shown at the top of the display as "hours: minutes: seconds: frames" (there are 30 frames per second). You can move the current recorder position to a specific time by inputting it here.

- 1 On the Home Screen, use the **HOME** button to move the cursor (underline) between time divisions. You can edit the value at the cursor positions. The seconds are selected in the following figure.



7 – Recorder Functions

- Turn the **DATA** wheel to change the value above the cursor. When adjusting, the value will carry over automatically when it reaches the highest or lowest value in a field. For example, when turning the **DATA** wheel to increase the value in the seconds field, the number will change from 59 to 0 and the minutes value will increase by one. The time display blinks when using the **DATA** wheel. The blinking stops when the recorder moves to the displayed position.
- Press the **HOME** button to move to a different time division and turn the **DATA** wheel to change the value.
- After setting the desired time value, press the **PLAY** (▶) button to start playback from that position.

Location marks

The unit can store up to 999 location marks per song! Use these to mark the start of verses, vocal entry points, etc.

To set a location mark

While stopped, recording or playing, press and hold the **LOCATE LIST [LOCATE SET]** button at the point where you want the new mark.

The mark number is shown next to the **F** icon on the Home Screen. The mark number you see is the one at or immediately before the current position. In the example below, 001 indicates the first mark in the selected song.



NOTE

Marks are numbered in the order you enter them, not according to their position in the song. Mark 005 can therefore appear in a song before mark 001.

To move to a location mark

Press the **LOCATE LIST [LOCATE SET]** to show the location mark list:

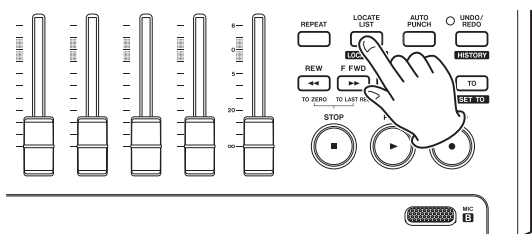

Use the **DATA** wheel to choose a mark (they're listed in the order they appear in the song) and press **F4 (JUMP)** to jump to that mark.

NOTE

- Press the **F1 (EXIT)**, **LOCATE LIST [LOCATE SET]** or **HOME** button to return to the Home Screen.
- If the current song does not have any location marks, the location mark list will not open. A No Locate Mark pop-up appears briefly and then the I/O SETTING screen opens.

To delete a location mark

You can erase a location mark when the recorder is stopped.

- Press the **LOCATE LIST [LOCATE SET]** button to show the location mark list.



- Use the **DATA** wheel to select a mark and press the **F2 (EDIT)** to bring up the edit screen.



- Press the **F2 (DEL)** button to erase that mark and return to the **LOCATE LIST** screen.
- Press the **F1 (EXIT)**, **LOCATE LIST [LOCATE SET]** or **HOME** button to return to the Home Screen.

NOTE

- The marks are shown in the order they appear in the song, not by number.
- This operation cannot be undone. Be certain before executing it.

To edit a location mark

If you made a mistake when you entered a location mark, you can change the time of the mark.

TIP

This is sometimes called "trimming".

- Press the **LOCATE LIST [LOCATE SET]** button to show the location mark list.



7 – Recorder Functions

- Use the **DATA** wheel to select a mark and press the **F2** (**EDIT**) to bring up the edit screen.



NOTE

- The marks are shown in the order they appear in the song, not by number.
- Use the **F3** (◀) and **F4** (▶) buttons to move the cursor between time fields.
 - Turn the **DATA** wheel to change the value above the cursor. When adjusting, the value will carry over automatically when it reaches the highest or lowest value in a field. For example, when turning the **DATA** wheel to increase the value in the seconds field, the number will change from 59 to 0 and the minutes value will increase by one.

NOTE

You can't move a mark forward past the next mark in the list, or backwards to before the previous mark in the list.

- After you have finished editing, press the **F1** (**EXIT**) button to confirm the edited value and return to the **LOCATE LIST** screen.

Return To Zero (TO ZERO) and Last Recording Position (TO LAST REC)

Use simple button operations to return to the top of a song or to the position where recording last started.

Return to the zero point (song beginning at 00:00:00:00)

Press the **REW** (◀◀) (**TO ZERO**) button while pressing and holding the **STOP** (■) button. (**TO ZERO** function)

Last Recording Position (the position recording last started)

Press the **F FWD** (▶▶) (**TO LAST REC**) button while pressing and holding the **STOP** (■) button.

This function is useful when you want to record the same passage again.

Fast forward/rewind search

Press the **REW** (◀◀) (**TO ZERO**) or **F FWD** (▶▶) (**TO LAST REC**) button when stopped to rewind or fast forward, respectively.

Each time you press one of these keys, the speed increases from 10x to 50x, 100x and 1000x.

Press these buttons during playback to search backward or forward while pressing. The search speed is fixed at 10 times normal playback speed.

Repeat playback

Use the repeat playback function to play the same part again and again.

The repeated passage is time between the **IN** and **OUT** points.

Using IN, OUT and TO points

In addition to setting the repeat playback interval, the **IN** and **OUT** points are also used to set track editing intervals and as the punch in and punch out points when automatically punching in and out. Moreover, these points are used as the starting and ending points when creating a master track.

You can set these points during recording, playback or when the unit is stopped.

NOTE

The **IN**, **OUT** and **TO** points cannot be set or edited at the following times.

- During repeat playback
- When in automatic punch in and out mode
- When the recorder is in **MIXDOWN** or **MASTERING** mode
- When the **LOCATE LIST** or **I/O SETTING** screen is open

Setting IN, OUT and TO points

Regardless of whether the unit is stopped, playing back or recording, you can set these points at the positions you like by pressing and holding the **IN [SET IN]**, **OUT [SET OUT]** or **TO [SET TO]** button. The corresponding **IN**, **OUT** or **TO** point is set at the time when you began pressing and holding the button, and the time set appears below a pop-up message (**SET IN !**, **SET OUT !** or **SET TO !** as appropriate).



SET IN pop-up message

Locating to IN, OUT and TO points

Regardless of whether the unit is stopped or playing back, you can press the **IN [SET IN]**, **OUT [SET OUT]** or **TO [SET TO]** button to locate the corresponding point.

You can also use the **I/O SETTING** screen to locate.

- Press the **LOCATE LIST [LOCATE SET]** button to open a list of location marks.



- Press the **F3** (**POINT**) button to open the **I/O SETTING** screen.



7 – Recorder Functions

NOTE

If the current song does not have any location marks, the location mark list will not open. A “No Locate Mark” pop-up appears briefly and then the I/O SETTING screen opens.

- Use the **DATA** wheel to select the mark, and press the **F4** (JUMP) button to locate to the designated point.

Editing IN, OUT and TO points

- Press the **LOCATE LIST [LOCATE SET]** button to open the location mark list.

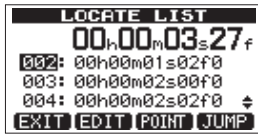

- Press the **F3 (POINT)** button to open the I/O SETTING screen.



NOTE

If the current song does not have any location marks, the location mark list will not open. A No Locate Mark pop-up appears briefly and then the I/O SETTING screen opens.

- Use the **DATA** wheel to select a mark, and press the **F2** (EDIT) button to open the I/O SETTING screen in editing mode.



- Use the **F3** (◀) and **F4** (▶) buttons to move the time unit cursor.
- Use the **DATA** wheel to change the value of the unit at the cursor. The larger adjacent time unit will automatically increase or decrease when a unit is turned past its high or low limit. For example, when the **DATA** wheel is turned to increase the second unit past 59, it will become “00” and the minute unit will increase by one.
- Press the **F1** (EXIT) button when you are done editing the point to confirm the value and return to the I/O SETTING screen.

- Press the **F4** (JUMP) button to locate to the point.
To return to the home screen without locating to the point, press the **F1** (EXIT) or **HOME** button instead.

Using repeat playback

- Set the starting (IN) and ending (OUT) points for the time that you want to repeat, and then return to the Home Screen.
- Press the **REPEAT** button to start repeat playback. The repeat icon on the Home Screen appears.

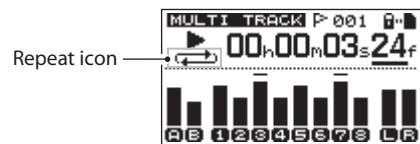
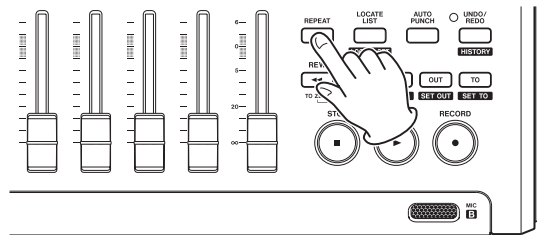

Playback starts from the IN point. When the OUT point is reached, after the repeat interval elapses, playback starts again from the IN point. Playback continues to repeat between the IN and OUT points.

- Press the **REPEAT** button again to stop repeat playback. The repeat icon on the Home Screen disappears.

The next section explains how to set the repeat interval that determines the amount of time until playback starts again after the OUT point is reached.

Setting the interval between repetitions

The interval can be set from 1.0 to 9.9 seconds.

- When the recorder is stopped, press the **MENU** button to open the MENU screen.
- Turn the **DATA** wheel to select **PREFERENCE**, and press the **F4** (▶) button to open the PREFERENCE screen.
- Use the **F3** (▲) and **F4** (▼) buttons to select the setting value for the Repeat Int. item. Turn the **DATA** wheel to set the value from 1.0 to 9.9 sec. in 0.1-sec. units.

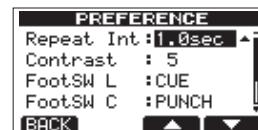

The default setting is 1.0sec.

- When finished making settings, press the **HOME** button to return to the Home Screen.

Automatically punching in and out

When an IN point and an OUT point are set, press the **AUTO PUNCH** button to enter auto punch in/out mode.

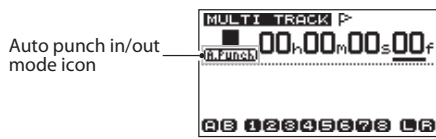

Auto punch in/out mode includes a rehearsal function. When using this function, monitoring between the IN and OUT points in the same way as when recording is possible without actually recording.

Rehearsal

- 1 When the recorder is stopped, press the **MENU** button to open the **MENU** screen.
- 2 Press the **REC** buttons on tracks to use auto punch in/out with them.
- 3 After setting the IN and OUT points, press the **AUTO PUNCH** button to enter auto punch in/out mode.

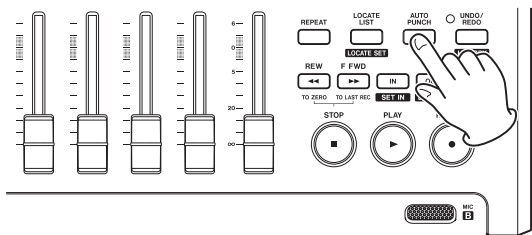

- 4 Press the **PLAY** (▶) key. Playback begins from two seconds before the IN point, and the sound monitored on the recording track(s) switches at the IN point from the track playback sound and the input sound to just the input sound. The **RECORD** (●) indicator blinks when between the IN and OUT points.

When playback reaches the OUT point, the track playback sound and the input sound becomes the monitored sound again, and the **RECORD** (●) indicator stops blinking and turns off. Playback automatically stops one second after the OUT point.

You can repeat rehearsal until you are satisfied.

Using auto punch in/out to record

When you are done rehearsing, you can use auto punch in/out for recording.

- 1 While in auto punch in/out mode, press and hold the **RECORD** (●) button, and press the **PLAY** (▶) button. In the same way as during rehearsal, playback begins from two seconds before the IN point. Recording occurs and the **RECORD** (●) indicator lights between the IN and OUT points.
2. One second after reaching the OUT point, the recorder automatically stops, auto punch in/out mode is exited and the transport locates to two seconds before the IN point.

NOTE

- *Auto punch in/out mode cannot be entered during repeat mode or if no REC button has been pushed.*
- *Auto punch in/out can be undone.*

8 – Editing Tracks

Editing on a conventional tape recorder in the past required advanced techniques, but with this unit editing tracks is easy and accurate. Moreover, with a tape recorder, an editing error could not be undone, but this unit uses nondestructive editing, allowing you to edit without altering the original data. This means that the undo function can be used to correct an edit easily (see *“Undoing the last operation (single undo)”* on page 36).

Overview of track editing

This unit has the following track editing functions.

- COPY/PASTE (copy and paste)
- COPY/INSERT (copy and insert)
- MOVE/PASTE (move and paste)
- MOVE/INSERT (move and insert)
- OPEN (insert a silent section)
- CUT (remove part of a track)
- SILENCE (erase part of a track)
- CLONE TRACK (duplicate a track)
- CLEAN OUT (erase a track)

Editing points

Among the track editing functions, COPY/PASTE, COPY/INSERT, MOVE/PASTE and MOVE/INSERT use the IN and OUT points as editing points. They also use the current position when the editing operation is begun as the TO point. SILENCE, CUT, and OPEN use the IN and OUT points. These IN and OUT points are the same IN and OUT points used during repeat playback. See *“Using IN, OUT and TO points”* on page 41 for instructions about how to do this.

IN point

The IN point is the starting point for the part of the track subject to track editing.

The IN point is set at the time when you begin pressing the **IN [SET IN]** button.

OUT point

The OUT point is the ending point for the part of the track subject to track editing.

The OUT point is set at the time when you begin pressing the **OUT [SET OUT]** button.

TO point

The TO point is used as the PASTE destination point for COPY and MOVE operations.

The TO point is set at the time when you begin pressing the **TO [SET TO]** button.

The IN, OUT and TO points can also be changed on various editing screens.

Basic editing procedures

- 1 When the recorder is stopped and the Home Screen is open, press the **TRACK EDIT** button to open the **TRACK EDIT** screen.



- 2 Use the **DATA** wheel to select the desired track editing function, and press the **F4 (▶)** button to open that function's screen.



- 3 Select the setting item value. If there are multiple setting items, use the **F3 (▲)** and **F4 (▼)** buttons to select one. Turn the **DATA** wheel to set an item's value.
- 4 Press the **F2 (EXEC)** button to execute the function. Press the **F1 (BACK)** button to return to the **TRACK EDIT** menu screen without executing the function.

Explanation of items

- SOURCE TRK
- OPEN TRK
- CUT TRK
- SILENCE TRK
- CLEAN OUT TRK

This is the track to be edited. The choices available depend on the editing function.

- 1 to 8: single tracks
- 1/2, 3/4, 5/6, 7/8: track pairs
- 1-8: all tracks
- MST: stereo master track
- ALL: all tracks or the stereo master track



SOURCE TRK screen

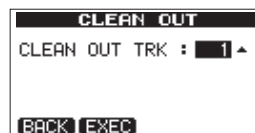

CLEAN OUT TRK screen

IN/OUT/TO

These points are used for editing. To change the IN, OUT or TO point, use the **F3 (▲)** and **F4 (▼)** buttons to select one. Then, use the **REW (◀◀) (TO ZERO)** and **F FWD (▶▶) (TO LAST REC)** buttons to move the cursor and the **DATA** wheel to set the time.



IN point editing screen



OUT point editing screen



TO point editing screen

DESTINATION TRK

Select the track that you want to be the destination for a COPY, INSERT or MOVE operation. The choices depend on what you have already chosen for the **SOURCE TRK** as the track to be edited.

When a single track has been set as the **SOURCE TRK**, the **DESTINATION TRK** choices are 1 to 8 (single tracks).

When a track pair (for example, 1/2) has been set as the **SOURCE TRK**, the **DESTINATION TRK** choices are 1/2, 3/4, 5/6 and 7/8 (track pairs).

When 1-8 (all tracks) has been set as the **SOURCE TRK**, the **DESTINATION TRK** choice is 1-8 (all tracks). In other words, this setting cannot be changed in this case.



COPY TIMES

Set the number of times that the copied section will be pasted. Set the number between 1 and 99.



COPY/PASTE

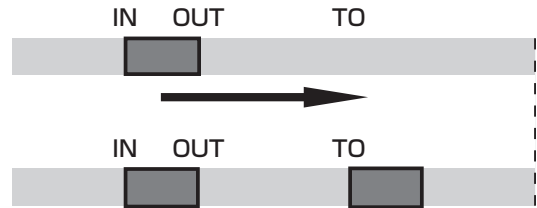

This function copies the audio data from between the IN and OUT points on the COPY source track, and pastes it on the COPY destination track starting from the TO point. This operation does not change the COPY source track.

This operation overwrites recorded data on the COPY destination track. Therefore, the length of the COPY destination track is not changed.

You can make multiple copies in a single operation. In other words, you can overwrite the COPY destination track from the TO point with a designated number of repetitions of the COPY data.

The following parameters are used in this operation.

- SOURCE TRK (1 to 8, 1/2, 3/4, 5/6, 7/8, 1-8)
- IN/OUT/TO
- DESTINATION TRK
- COPY TIMES

COPY/INSERT

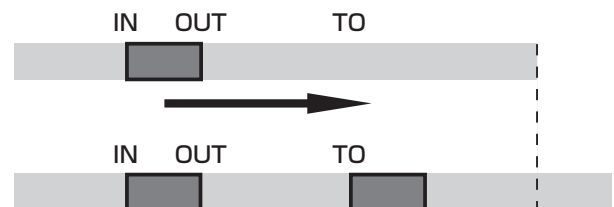

This function copies the audio data from between the IN and OUT points on the COPY source track, and inserts it on the COPY destination track starting from the TO point. This operation does not change the COPY source track.

8 – Editing Tracks

This operation inserts recorded data into the COPY destination track. The recorded data on the COPY destination track after the TO point is offset by the amount of time used by the inserted audio data. Therefore, the COPY destination track becomes longer.

You can make multiple copies in a single operation. In other words, you can insert a designated number of repetitions of the COPY data into the COPY destination track from the TO point.

The following parameters are used in this operation.

- SOURCE TRK (1 to 8, 1/2, 3/4, 5/6, 7/8, 1-8)
- IN/OUT/TO
- DESTINATION TRK
- COPY TIMES

MOVE/PASTE

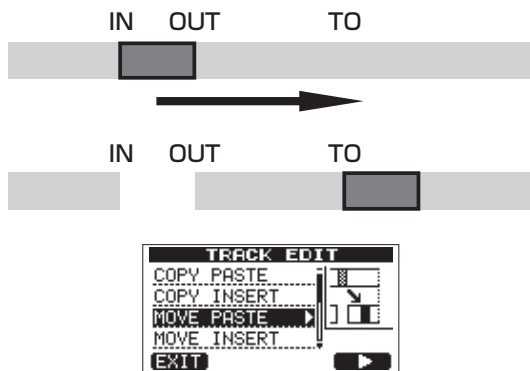

The audio data between the IN and OUT points on the MOVE source track is removed and pasted in the MOVE destination track starting from the TO point. This operation leaves a silence between the IN and OUT points on the MOVE source track.

This operation overwrites recorded data on the MOVE destination track. Therefore, the length of the MOVE destination track is not changed.

The following parameters are used in this operation.

- SOURCE TRK (1 to 8, 1/2, 3/4, 5/6, 7/8, 1-8)
- IN/OUT/TO
- DESTINATION TRK

MOVE/INSERT

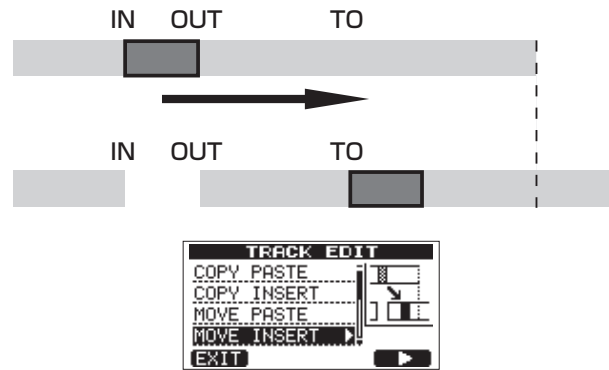

The audio data between the IN and OUT points on the MOVE source track is removed and inserted in the MOVE destination track from the TO point. This operation leaves a silence between the IN and OUT points on the MOVE source track.

This operation inserts recorded data into the MOVE destination track starting from the TO point. Therefore, the MOVE destination track becomes longer.

The following parameters are used in this operation.

- SOURCE TRK (1 to 8, 1/2, 3/4, 5/6, 7/8, 1-8)
- IN/OUT/TO
- DESTINATION TRK

OPEN (insert silence)

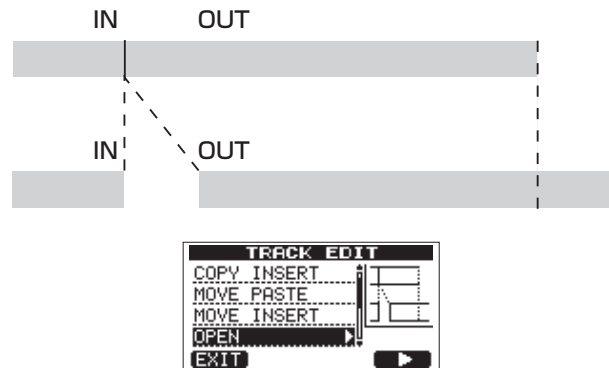

This function inserts silence between the IN and OUT points on the selected track.

This function splits the track at the IN point and shifts the recorded data after the IN point to after the OUT point. Therefore, the track becomes longer.

The following parameters are used in this operation.

- OPEN TRK (1 to 8, 1/2, 3/4, 5/6, 7/8, 1-8, ALL)
- IN/OUT

CUT (remove part)

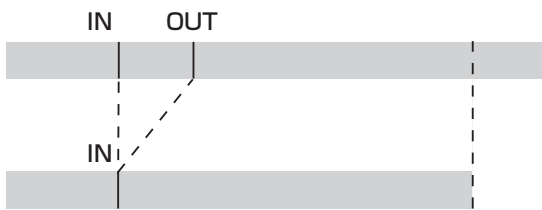

This function cuts (deletes) the audio data between the IN and OUT points on the selected track, and shifts the remaining recording after the OUT point forward to the IN point. Therefore, the track becomes shorter.

The following parameters are used in this operation.

- CUT TRK (1 to 8, 1/2, 3/4, 5/6, 7/8, 1-8, ALL)
- IN/OUT

SILENCE (part erase)

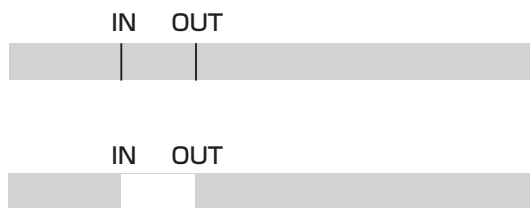

This function cuts (deletes) the audio data between the IN and OUT points on the selected track, leaving silence between the IN and OUT points, as though there had been no recording.

This operation does not change the length of the track.

The following parameters are used in this operation.

- SILENCE TRK (1 to 8, 1/2, 3/4, 5/6, 7/8, 1-8)
- IN/OUT

TIP

Using this function, you can delete short noises, for example.

CLONE track (track duplication)

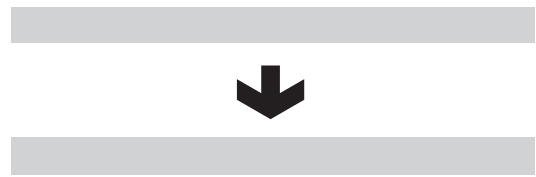

Use this function to duplicate a single track, a track pair or the stereo master track on a different track or track pair. Each track is copied entirely, so the IN/OUT/TO points have no effect.

The following parameters are used in this operation.

- SOURCE TRK (1 to 8, 1/2, 3/4, 5/6, 7/8, 1-8, MST)
- DESTINATION TRK

NOTE

If you choose the same track for both the SOURCE TRK and the DESTINATION TRK and press the F2 (EXEC) button, the Same Track message appears and the operation is not executed.

CLEAN out (track erase)



Use this function to completely erase the selected track. This erases the entire track, so the IN, OUT and TO points have no effect.

The following parameter is used in this operation.

- CLEAN OUT TRK (1 to 8, 1/2, 3/4, 5/6, 7/8, 1-8)

9 – Mixing down and mastering tracks

Mixing down tracks

Mixing down tracks is the process of adjusting the volumes and stereo positions of each recorded track and mixing them into a well-balanced stereo track.

Levels and balance

Use the **TRACK 1-8** faders to adjust the relative balance of the tracks. Then use the **MASTER** fader to adjust the overall level. Watching the **L** and **R** meters on the display, adjust the level until it is suitable.

If the volume is too loud, the sound will be distorted.

NOTE

The track meters on the display show the recorded signal levels of the tracks. Therefore, these meters do not change when the TRACK faders are adjusted.

TIP

You do not need to keep the entire song at the same volume. For example, you could gradually increase the volume during a guitar solo.

Stereo position (panning)

Use the **PAN** knobs of the tracks to adjust the stereo positions of their signals.

Track EQ (equalizer)

Each track has a 2-band equalizer (EQ).

Set the track EQ using the EQ SETTING screen.

- 1 Press the **EQ** button to open the EQ SETTING screen.

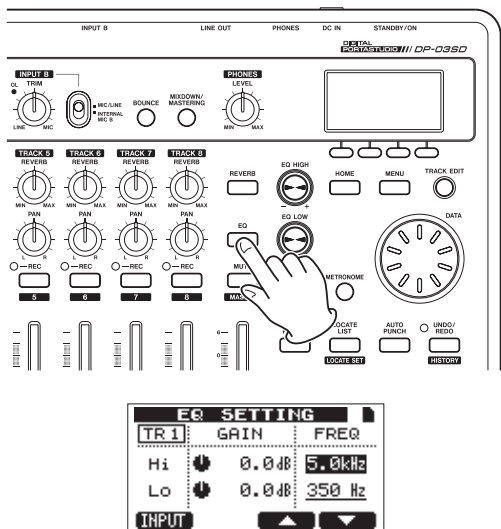

- 2 Set the track EQ (equalizer).
The track equalizer has the following parameters.

	GAIN	FREQ
Hi	High-frequency gain Setting range: ± 12 dB (Default value: 0.0 dB)	High-frequency value Setting range: 1.7–18 kHz (Default value: 5 kHz)
Lo	Low-frequency gain Setting range: ± 12 dB (Default value: 0.0 dB)	Low-frequency value Setting range: 32 Hz–1.6 kHz (Default value: 350 Hz)

Use the **REC** button to select the track.

Use the **EQ HIGH** knob to adjust the **Hi** gain and the **EQ LOW** knob to adjust the **Lo** gain.

Use the **F3** (**▲**) and **F4** (**▼**) buttons to select **Hi** or **Lo**, and use the **DATA** wheel to set the **FREQ** value.

Press the **F1** (**INPUT**) button to make **INPUT EQ** settings. (See “Using input EQ (equalizer)” on page 34.)

- 3 After making the setting, press the **HOME** button to return to the Home Screen.

NOTE

When track EQ is applied to a track, the track is shown on the Home Screen as in the illustration below.

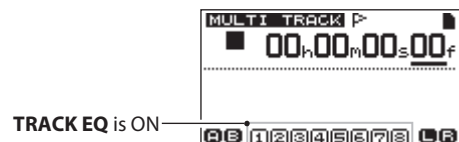

Track EQ is used on all tracks in the example above.

Reverb

This unit has six types of reverb effects.

Adjust the level of the signal sent to the reverb effect from each track by using their **REVERB** knobs.

NOTE

Both reverb and track EQ (equalization) can be used the same time. The reverb is applied after the track EQ.

9 – Mixing down and mastering tracks

- 1 Press the **REVERB** button to open the **REVERB SETTING** screen.

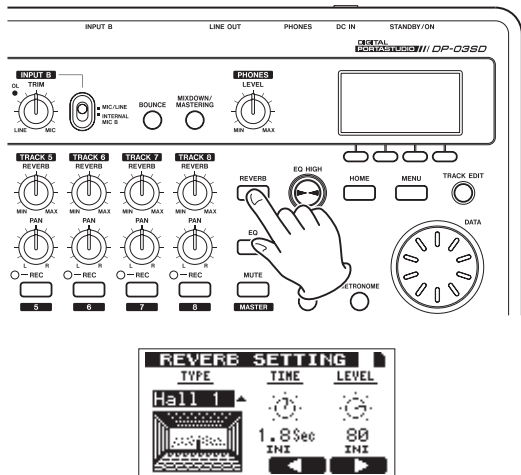

- 2 Set the reverb using the following parameters.

Parameters		Setting values
TYPE	Reverb type	Hall 1, Hall 2, Room, Studio, Plate 1, Plate 2 (Default: Hall 1)
TIME	Reverb time (depth)	0.2 (0.8 for Plate types) – 3.2 Sec
LEVEL	Reverb amount (volume)	0–100

Use the **F3** (◀) and **F4** (▶) buttons to select parameters, and use the **DATA** wheel to set the parameters. The reverb return signal (signal after the effect is applied) is mixed into the stereo signal.

- 3 After making the reverb setting, press the **HOME** button to return to the Home Screen.
- 4 Use the track **REVERB** knobs to adjust the amount of track signal sent to the reverb effect.

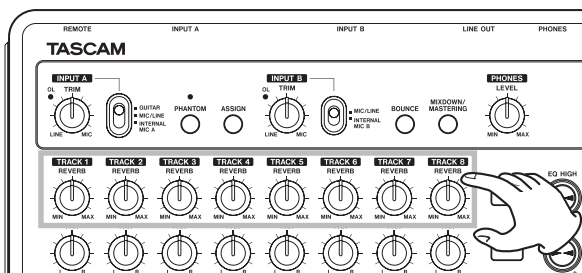

NOTE

The default values of each reverb type are as follows.

TYPE	Default values	
	TIME	LEVEL
Hall 1	1.8	80
Hall 2	2.2	80
Room	1.4	10
Studio	0.6	20
Plate 1	1.4	60
Plate 2	1.8	60

When a setting value is the same as the default value for the reverb type, **INI** appears below that setting value.

Muting tracks

- 1 Press the **MUTE** button to open the **TRACK MUTE** screen.

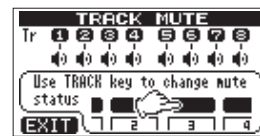
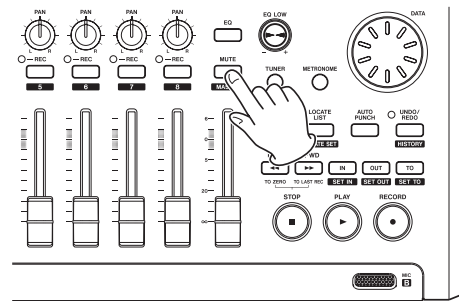

- 2 Press the **REC** button of each track to turn mute ON or OFF for it. When mute is ON, the track number is shown in inverse (dark number on light background).

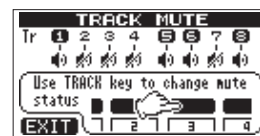

Tracks 2,3,4 and 7 are muted in the example above.

- 3 After muting the desired tracks, press the **HOME** button to return to the Home Screen.

NOTE

When tracks are muted, their track numbers also appear in inverse (dark number on light background) on the Home Screen as shown below.

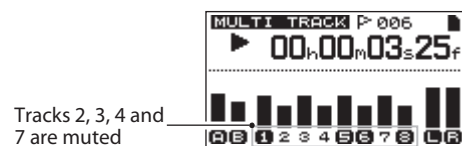

Tracks 2, 3, 4 and 7 are muted

Creating a stereo master track

When you are satisfied with your mix, this unit can record the mixed down tracks and create a stereo master track internally.

9 – Mixing down and mastering tracks

A stereo master track recorded by this unit is saved as part of the song.

This stereo master track can be recorded by an external stereo recorder, and can also be converted by the unit into a WAV file and exported to a computer. (See “Exporting a stereo master track” on page 65.)

NOTE

Only one stereo master track can be saved in each song.

Setting the starting and ending points

Before creating a stereo master track, set the stereo master track start and end points. The time between the song’s IN point and the OUT point will be recorded as the stereo master track.

Ordinarily, set the beginning of the song as the IN point and the end of the song as the OUT point.

Press and hold the **IN [SET IN]** button where you want to set the start (IN) point of the stereo master track, and press and hold the **OUT [SET OUT]** button where you want to set the end (OUT) point.

For details about how to change the IN and OUT points, see “Using IN, OUT and TO points” on page 41.

Recording a stereo master track

After setting the IN and OUT points, you are ready to record the stereo master track.

- 1 In MULTITRACK mode, press the **MIXDOWN/MASTERING** button.

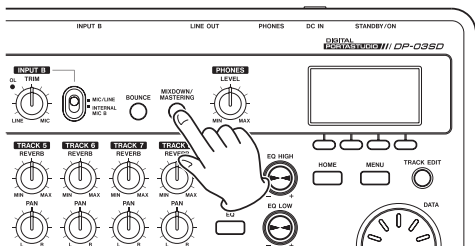

After the Mixdown ! pop-up message appears the unit switches to MIXDOWN mode and the Home Screen reopens.



In this state, if you play back or record, you can hear the signal of the mixed tracks (the signal being recorded) through headphones or a monitoring system.

NOTE

- When in MIXDOWN mode, MIXDOWN appears in the bar at the upper left of the display.
- If you try to enter MIXDOWN mode when the length of the interval between IN and OUT points is less than 4 seconds, a Trk Too Short pop-up message appears and you cannot enter MIXDOWN mode.
- In MIXDOWN mode, you cannot change the IN, OUT or TO points.

- Some playback functions and other functions do not work when the unit is in mixdown mode. If you try to use one of these functions, an “In Mixdown Mode” pop-up message appears.

- 2 Press and hold the **RECORD (●)** button and press the **PLAY (▶)** button to start the mixdown. The **RECORD (●)** button indicator lights.

Regardless of the recorder’s current playback position, the mixdown starts from the IN point.

Use the TRACK faders and PAN knobs as necessary to mix the tracks to stereo. These adjustments will be reflected in the stereo master track.

When the recorder reaches the OUT point, recording automatically stops.

- 3 If you want to redo the creation of the stereo master track, press and hold the **RECORD (●)** button and press the **PLAY (▶)** button to begin. A new stereo master track will be created, and the previous stereo master track will be overwritten.

NOTE

After recording the stereo master track, you can play back the stereo master track to check it. (See “Checking the stereo master track” on page 51.)

TIP

You can also undo the creation of a stereo master track. In other words, after recording the stereo master track multiple times, you can undo and use a stereo master track that you recorded earlier.

Exiting MIXDOWN mode

Press the **MIXDOWN/MASTERING** button twice to return to MULTITRACK mode.

9 – Mixing down and mastering tracks

Checking the stereo master track

Follow these procedures to listen to a stereo master track after you have completed recording it.

- 1 In MIXDOWN mode, press the **MIXDOWN/MASTERING** button.
After the Mastering ! pop-up message appears the unit switches to MASTERING mode and the Home Screen reopens.

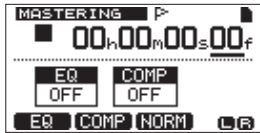

NOTE

- When in MASTERING mode, MASTERING appears in the bar at the upper left of the display.
 - When in MULTITRACK mode, press the **MIXDOWN/MASTERING** button to activate MIXDOWN mode, and then press the **MIXDOWN/MASTERING** button again to activate MASTERING mode.
 - MASTERING mode cannot be entered if there is no stereo master track.
- 2 In this state, press the **PLAY** (▶) button to start playback of the stereo master track.

NOTE

Confirm that both the EQ and COMP items are shown to be OFF. If either is ON, the sound heard will be affected by the equalizer and/or compressor. (See "Using mastering EQ (equalizer)" on page 52 and "Using mastering compression" on page 52.)

- 3 In MASTERING mode, the transport controls have the following functions.
 - Press the **PLAY** (▶) button to play the stereo master track from the current position until its end.
 - Use the **REW** (◀◀) (**TO ZERO**) and **F FWD** (▶▶) (**TO LAST REC**) buttons to search backward and forward, in the same way as in MULTITRACK mode.
 - Press the **STOP** (■) button to stop playback.
 - Ordinary recording is not possible.
 - Repeat and location mark functions cannot be used.

Since the stereo master track playback signal is output from the **PHONES** jack and **LINE OUT** jacks, you can record the output to an external stereo recorder.

If you are not happy with the completed stereo master track, you can conduct a mixdown again.

NOTE

To listen to a stereo master track recorded in a saved song, load that song, set the recorder mode to MASTERING, and press the **PLAY** (▶) button to start playback.

TIP

A stereo master track can be copied to any track pair among tracks 1–8 by creating a "clone" track (see "CLONE track (track duplication)" on page 47).

End stereo master track checking

When you are done checking the stereo master track, press the **MIXDOWN/MASTERING** button to return to MULTITRACK mode.

Mastering the stereo master track

This unit has specialized tools for mastering the stereo master track. Use multi-band compression, equalization and normalization to adjust the overall volume and sound quality. Put the unit into MASTERING mode and use the mastering tools to finish (master) the stereo master track.

Mastering procedures

Follow these steps to master a stereo track.

Step 1. Enter MASTERING mode.

In mixdown mode, press the **MIXDOWN/MASTERING** button.

After the Mastering ! pop-up message appears the unit switches to MASTERING mode and the Home Screen reopens.

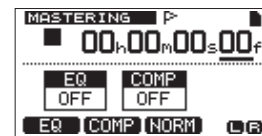

NOTE

- When in MULTITRACK mode, press the **MIXDOWN/MASTERING** button to activate MIXDOWN mode, and then press the **MIXDOWN/MASTERING** button again to activate MASTERING mode.
- MASTERING mode cannot be entered if there is no stereo master track.

Step 2. Use the mastering tools to adjust the sound of the track. Press the **F1** (EQ), **F2** (COMP) or **F3** (NORM) button to open the screen for the desired tool.

These include MASTERING EQ (equalizer), MASTERING COMP (compressor) and NORMALIZE screens. You can also select either a single band or multi-band compressor using the library. The multi-band compressor screen is split into a LOW BAND, a MID BAND and a HIGH BAND.

Make settings for each on their screens. (For details, see "Using mastering compression," "Using mastering EQ (equalizer)" and "Normalizing" below.)

In MASTERING mode, since you can use the **PLAY** (▶), **STOP** (■), **REW** (◀◀) (**TO ZERO**) and **F FWD** (▶▶) (**TO LAST REC**) transport buttons, adjust the settings as you monitor the playback signal.

Step 3. Record with mastering effects.

After adjusting the settings of the mastering tools, press and hold the **RECORD** (●) button and press the **PLAY** (▶) button to start recording. During recording, the **PLAY** (▶) and **RECORD** (●) indicators light.

Recording always starts from 00:00:00:00 regardless of the current position.

Recording in MASTERING mode overwrites the stereo master track.

9 – Mixing down and mastering tracks

NOTE

If you stop recording in the middle, a stereo master track will be created until the time when you stopped the unit.

Step 4. Check the mastered recording.

Turn the equalizer and compressor OFF before playing back the mastered stereo track to check the results of mastering. Undo and redo can be used, so you can compare the sound before and after mastering.

If you are not satisfied with the result:

Undo the recording to restore the stereo master track to the state before being overwritten and repeat the mastering procedures above from Step 1.

NOTE

Undo and redo cannot be used when the unit is in MASTERING mode. Switch to MULTITRACK or MIXDOWN mode to use these functions.

Using mastering EQ (equalizer)

- When the MASTERING screen is open, press the **F1 (EQ)** button to open the MASTERING EQ screen.

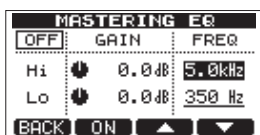

- Set the mastering equalizer using the following parameters.

	GAIN	FREQ
Hi	High-frequency gain Setting range: ± 12 dB (Default value: 0.0 dB)	High-frequency value Setting range: 1.7–18 kHz (Default value: 5 kHz)
Lo	Low-frequency gain Setting range: ± 12 dB (Default value: 0.0 dB)	Low-frequency value Setting range: 32 Hz–1.6 kHz (Default value: 350 Hz)

Use the **EQ HIGH** knob to adjust the **Hi** gain and the **EQ LOW** knob to adjust the **Lo** gain.

Use the **F3 (▲)** and **F4 (▼)** buttons to select Hi or Lo, and use the **DATA** wheel to set the **FREQ** value.

Whether the mastering equalizer is **ON** or **OFF** is shown in the upper left of the display. When **OFF**, press the **F2 (ON)** button to turn EQ **ON**, and when **ON** press the **F2 (OFF)** button to turn EQ **OFF**.



- After making the setting, press the **F1 (BACK)** button to return to the Home Screen. The EQ item on the MASTERING screen shows whether the mastering equalizer is currently **ON** or **OFF**.

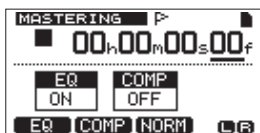

Using mastering compression

You can select either a single band or multi-band type of mastering compressor from the library.

Multi-band compressors divide the stereo master track into low, mid and high frequency ranges that can be processed using independent settings, allowing adjustment of the overall volume balance.

By using compression, you can reduce unwanted peaks and increase the overall gain in order to raise the volume, creating a mastered sound with greater impact.

- When the MASTERING screen is open, press the **F2 (COMP)** button to open the MASTERING COMP screen.



- Press the **F3 (LIB)** button to open the library screen.

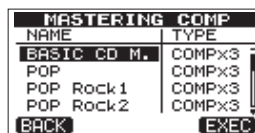

- Use the **DATA** wheel to select an item in the library, and press the **F4 (EXEC)** button to confirm the selection. Items with the **TYPE** of **COMPX3** are multi-band, while **COMPX1** items are single band compressors.

After the item loads from the library, the MASTERING COMP screen reopens.

- Next, press the **F4 (PARM)** button to open the parameter setting screen.

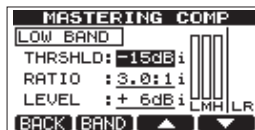

At this time, the selected band is shown in the upper left. If it is a multi-band compressor, press the **F2 (BAND)** button to change the band that you are adjusting. Each time you press this button, the band cycles through **LOW**, **MID** and **HIGH** band. For single band types, **F2** switches between **BAND** and **A. MAKEUP**.

- Use the **F3 (▲)** and **F4 (▼)** buttons to select the value of the item that you want to set, and use the **DATA** wheel to set it. When a setting is at its default value, an "i" appears next to it.

The setting items and their ranges are as follows.

THRESHLD: Set the threshold value that determines when the compressor begins to operate. (Range: -32 dB to 0 dB in 1 dB steps)

RATIO: Set the compression ratio. (1.0: 1, 1.1: 1, 1.3: 1, 1.5: 1, 1.7: 1, 2.0: 1, 2.5: 1, 3.0: 1, 3.5: 1, 4.0: 1, 5.0: 1, 6.0: 1, 8.0: 1, 16.0: 1, inf: 1)

LEVEL: Set the output level. (Range: -20 dB to +20 dB in 1 dB steps)

- When using a multi-band compressor, press the **F2 (BAND)** button to open the next band. Make settings as necessary for all bands.

9 – Mixing down and mastering tracks

- When using a single band compressor, press the **F2 (BAND)** button to show the **A. MAKEUP** setting.

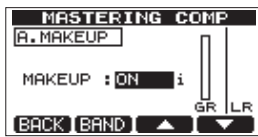

You can turn this automatic gain makeup function ON to automatically increase the volume when it is decreased by the compressor. When a setting is at its default value, an "i" appears next to it.

- After making the parameters settings, press the **F1 (BACK)** button to return to the **MASTERING COMP** screen.
- Use the **F2 (SW)** button to turn the compressor ON and OFF. The ON/OFF status is shown on the **MASTERING COMP** screen.

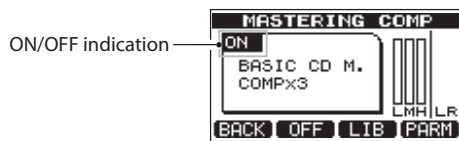

- When you have finished making the settings, press the **F1 (BACK)** button to return to the **MASTERING** screen. For information about compressor settings, see "14 – Mastering compressor settings list."

Using normalize

Use the normalize function to automatically adjust the volume. This function detects the highest volume level and raises the overall volume until the highest level reaches the maximum limit.

CAUTION

If you use equalization or compression after normalizing the track, distortion might occur. Use normalization after adjusting the sound quality with equalization and compression.

- When the **MASTERING** screen is open, press the **F3 (NORM)** button to open the **NORMALIZE** screen.

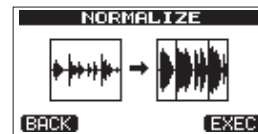

- Press the **F4 (EXEC)** button to normalize the track.
- After normalization completes, press the **F1 (BACK)** button to return to the **MASTERING** screen.

Copying the stereo master track

You can use the clone track function to copy the stereo master track to other tracks. (See "CLONE track (track duplication)" on page 47.)

Exiting MASTERING mode

Press the **MIXDOWN/MASTERING** button to exit **MASTERING** mode and return to ordinary **MULTITRACK** mode.

10 – Miscellaneous Functions

Metronome

This unit has a built-in metronome function that can be used when the recorder is operating. You can set it to function during both playback and recording or only during recording.

- 1 Press the **METRONOME** button to open the **METRONOME** screen.

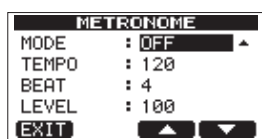
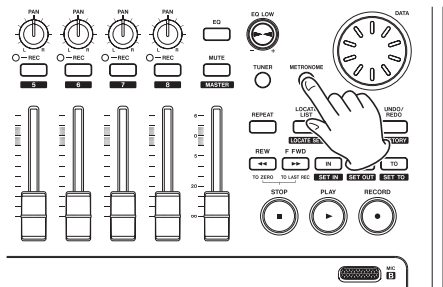

- 2 Set the following items. Use the **F3** (▲) and **F4** (▼) buttons to select each item, and turn the **DATA** wheel to change the value.

MODE

OFF	Default, metronome OFF
REC&PLAY	Functions both during recording and playback
REC ONLY	Functions only during recording

TEMPO

Set speed from 20 to 250 beats per minute (BPM). The default setting is 120.

BEAT

Set the frequency of the accent from 1 to 12 for different time signatures.

The default setting is 4.

LEVEL

Set the metronome volume from 0 to 100.

The default setting is 100.

- 3 When finished making settings, press the **HOME** button to return to the Home Screen. The metronome functions according to the **MODE** setting made in step 2 above. The metronome signal is not recorded even if set to operate during recording.

NOTE

- When the metronome is operating, you can monitor the sound of the metronome through connected external speakers. In this case, the metronome sound might also be recorded when you use a microphone to record.
- When the metronome is operating, you can adjust the **LEVEL**, but other items on the **METRONOME** screen cannot be changed. Moreover, during recording, you cannot open the **METRONOME** screen. You can adjust the **LEVEL** if you start recording while the **METRONOME** screen is open and do not switch to a different screen.

TIP

- You can use the metronome like a click track to help keep time when recording the first tracks (rhythm guitar, bass, etc.) in a song.
- If you want to use the metronome when practicing, you can either turn each track's fader all the way down during playback or play a song that does not have any recordings.

Tuner

Use the built-in chromatic tuner to tune guitars and wind instruments.

In addition to the chromatic tuner mode, which allows you to tune an instrument while looking at the tuning meter, this unit's tuner, also has an oscillator mode that outputs a standard pitch.

Chromatic tuner mode

- 1 Connect a guitar or bass to **INPUT A**. **INPUT B** cannot be used for tuning. Use built-in MIC A when tuning wind instruments, for example.
- 2 Set the **INPUT A** switch to **GUITAR** (see "Selecting the input sources" on page 33). To use the built-in mic, set the **INPUT A** switch to **INTERNAL MIC A**.

10 – Miscellaneous Functions

- When the recorder is stopped, press the **TUNER** button to open the **TUNER** screen.
The value of the **CALIB** item (standard frequency) is selected.

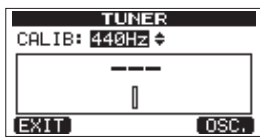
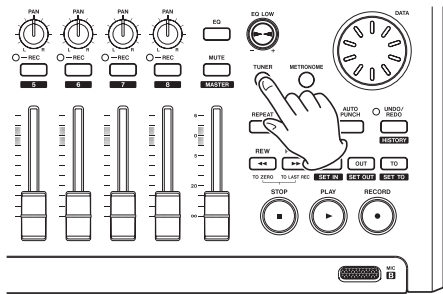

- Turn the **DATA** wheel to set the standard frequency of the A note between 435 and 445 Hz. The default setting is 440 Hz.
- Play the instrument and begin tuning. The pitch name closest to the string appears above the meters. Tune the string roughly until the sound name that you want appears. Then, fine tune the string until the rectangle at the middle of the meter darkens, showing that the string is in tune. If the pitch is too low, a bar extends to the left of the middle and if it is too high it extends to the right. The more out of tune, the longer the bar appears.

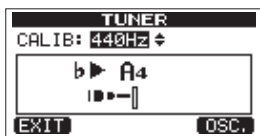

When the pitch played matches the note shown, the note name appears between the ► ◀ icons.

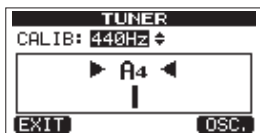

- When finished tuning, press the **HOME** button to return to the Home Screen.

NOTE

*If you want to monitor the input sound, press the **REC** button of a track that has **INPUT A** assigned to it.*

Oscillator mode

- When the recorder is stopped, press the **TUNER** button to open the **TUNER** screen.

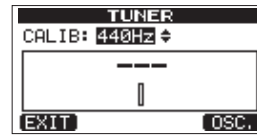

- Press the **F4** (**OSC.**) button to display the oscillator screen.

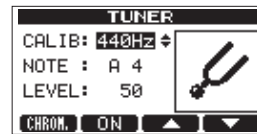

The following settings can be made on this screen.

CALIB

Use this to adjust the standard frequency of A4. The setting range is 435Hz–445Hz.

The default setting is 440Hz.

NOTE

Use this to set the note output. The setting range is C3–B5.

The default setting is A4.

LEVEL

Use this to set the output level. The setting range is 10 (minimum) – 100 (maximum).

The default setting is 50.

Use the **F3** (▲) and **F4** (▼) buttons to select parameters, and use the **DATA** wheel to set the parameter values.

Use the **F2** (ON) button to turn the output ON and OFF.

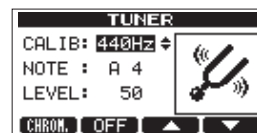

Use the **F1** (**CHROM**) button to change to chromatic tuner mode.

- When you have finished tuning, press the **HOME** button to return to the Home Screen.

10 – Miscellaneous Functions

Automatic power saving function

You can set the amount of time until the unit automatically turns OFF (enters standby) after its last activity or operation.

1. When the recorder is stopped, press the **MENU** button to open the MENU screen.
2. Use the **DATA** wheel to select (highlight) the **PREFERENCE** item and press the **F4** [▶] button to open the PREFERENCE screen.
3. Use the **F3** [▲] and **F4** [▼] buttons to select (highlight) the **Auto Power Save** item setting value, and use the **DATA** wheel to set it to one of the following values.

Options: OFF (does not turn off automatically), 3min, 5min, 10min, 30min (default value)

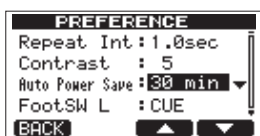

4. After completing the setting, press the **HOME** button to return to the Home Screen.

Restoring the initial preference settings

You can restore the PREFERENCE screen settings to their initial values (the values that they had when the unit was shipped from the factory). This operation is called initialization.

1. When the recorder is stopped, press the **MENU** button to open the MENU screen.
2. Turn the **DATA** wheel to select **PREFERENCE**, and press the **F4** (▶) button to open the PREFERENCE screen.



3. Use the **F3** (▲) and **F4** (▼) buttons to select **Exec** next to the **Initialize** item.

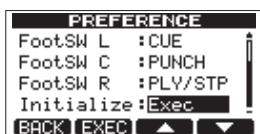

4. Press **F2** (EXEC) to open a confirmation screen.



5. Press **F3** (YES) to initialize the unit. The PREFERENCE screen reopens when the process finishes.

NOTE

Press the **F4** (NO) button to cancel initialization.

6. When finished, press the **HOME** button to return to the Home Screen.

Viewing information

You can view information about the current song, the SD card and the firmware.

1. Press the **MENU** button to open the MENU screen.
2. Turn the **DATA** wheel to select **INFORMATION** and press the **F4** (▶) button.



The INFORMATION screen **SONG (1/3)** page appears.



The INFORMATION screen has three pages including this one.

3. Use the **F3** (PREV) and **F4** (NEXT) buttons to change the page. The pages contain the following information. **SONG (1/3)** page: name and partition of currently loaded song, remaining recording time on partition



CARD (2/3) page: MTR partitions and capacities, FAT partition capacity



F/W (3/3) page: system firmware version



11 – SD Card Management

Overview of partitions

As described in “Partitions and songs” on page 30, SD cards formatted by this unit are divided into partitions. MTR partitions are for recording data while the FAT partition can be accessed with a personal computer.

The FAT partition is FAT32 format and can be accessed by a computer connected to this unit by USB. This FAT partition is used to save songs and export stereo master tracks to computers, as well as to allow this unit to import audio files into songs, for example. For this reason, two steps are necessary to copy from a MTR partition and a computer. You can also format an entire card or individual partition as well as change the divisions between partitions (repartition) as necessary.

CAUTION

Formatting and repartition operations cannot be undone!

NOTE

- The FAT (File Allocation Table) format is a disk format that can be read by a computer.
- SD cards that meet SD/SDHC standards and are at least 512 MB can be used with this unit.
A list of SD cards that have been confirmed for use with this unit can be found on our web site. Please access to a product page of this product from the TEAC Global Site (<http://teac-global.com>) to find the list or contact the TASCAM customer support service.

Formatting cards

This operation formats the entire card.

CAUTION

This operation erases all the data on the card and cannot be undone! Confirm that you will not lose important data before formatting a card.

- 1 When the recorder is stopped, press **MENU** to open the MENU screen.
- 2 Turn the **DATA** wheel to select **CARD**, and press the **F4** (▶) button to open the **CARD** menu screen.

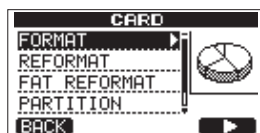
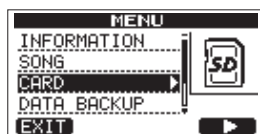

- 3 Turn the **DATA** wheel to select **FORMAT** and press the **F4** (▶) button.
The **FORMAT** screen opens.

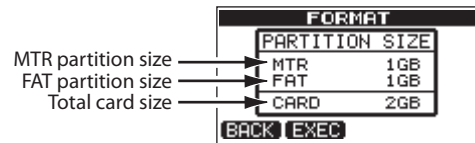

The following table shows the FAT and MTR partition sizes for different SD card capacities. The FAT partition size is set automatically according to card capacity.

Card capacity and partition size

Card capacity	FAT partition size	MTR partition size
32 GB	4GB	28 GB
16 GB	4GB	12 GB
8 GB	2GB	6 GB
4 GB	2 GB	2 GB
2 GB	1 GB	1 GB
1 GB	512 MB	512 MB
512 MB	256 MB	256 MB

A message warning that all songs will be erased appears.



- 4 Press the **F3** (YES) button to format the card.
For example, if you format a 16 GB card, 12 GB are left for MTR partitions after 4 GB is used for the FAT partition. (Since 1GB is actually 1024 MB, the total size of the partitions does not always match the card size.)
- When formatting finishes the **CARD** menu screen reopens.
 - After formatting, one song is automatically created in each MTR partition.
 - To cancel formatting, press the **F4** (NO) button.

11 – SD Card Management

Reformatting MTR partitions

You can reformat an MTR partition if you want. Use this function when you just want to format a specific partition without changing its size.

CAUTION

You cannot undo this operation! All the data on the selected MTR partition will be erased, so be certain that you will not lose anything important when reformatting.

- 1 When the recorder is stopped, press the **MENU** button to open the **MENU** screen.
- 2 Use the **DATA** wheel to select **CARD**, and press the **F4** (▶) button to open the **CARD** menu screen.

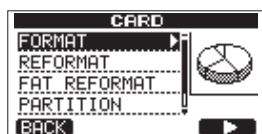
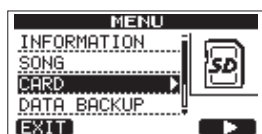

- 3 Turn the **DATA** wheel to select **REFORMAT**.



Press the **F4** (▶) button to open the **REFORMAT** screen.



A list of the MTR partitions and their sizes (not open capacities) appear.

A * marks the active partition.

- 4 Turn the **DATA** wheel to select the partition that you want to reformat and press the **F2** (EXEC) button.

A pop-up message warning that all data on the partition will be erased appears.



- 5 Press the **F3** (YES) button to reformat the partition.
 - When reformatting finishes the **CARD** menu reopens.
 - After reformatting, one song is automatically created in the MTR partition.
 - To cancel reformatting, press the **F4** (NO) button.

Reformatting the FAT partition

You can also reformat just the FAT partition. The size of the FAT partition cannot be changed.

CAUTION

You cannot undo this operation! All data on the FAT partition will be erased, so be certain that you will not lose anything important when reformatting.

- 1 When the recorder is stopped, press the **MENU** button to open the **MENU** screen.
- 2 Turn the **DATA** wheel to select **CARD**, and press the **F4** (▶) button to open the **CARD** menu screen.

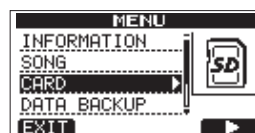

- 3 Turn the **DATA** wheel to select **FAT_REFORMAT**, and press the **F4** (▶) button.



A pop-up message warning that all data on the FAT partition will be erased appears.



- 4 Press the **F3** (YES) button to reformat the FAT partition.
 - When reformatting finishes the **CARD** menu screen reopens.
 - To cancel reformatting, press the **F4** (NO) button.

Viewing the capacity of the MTR partition

Follow these procedures to view the capacity of the MTR partition.

- 1 When the recorder is stopped, press the **MENU** button to open the **MENU** screen.
- 2 Use the **DATA** wheel to select **CARD**, and press the **F4 (▶)** button to open the **CARD** screen.

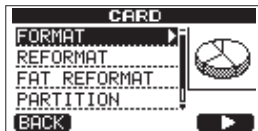
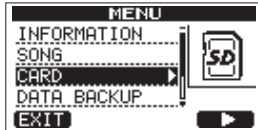

Use the **DATA** wheel to select **PARTITION**, and press the **F4 (▶)** button to open the **PARTITION** screen, where you can view the capacity of the MTR partition.



Initializing SD cards

If you want to use an SD card that was used with this unit on other equipment, we recommend that you initialize it.

When you initialize an SD card, the entire card is formatted as FAT32.

- 1 When the recorder is stopped, press the **MENU** button to open the **MENU** screen.
- 2 Turn the **DATA** wheel to select **CARD**, and press the **F4 (▶)** button to open the **CARD** menu screen.

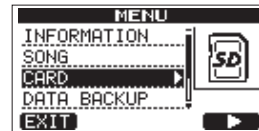

- 3 Turn the **DATA** wheel to select the **SD INITIALIZE** item and press the **F4 (▶)** button.

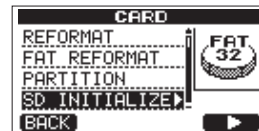

A pop-up message warning that all data on the card will be erased appears.



- 4 Press the **F3 (YES)** button to initialize the entire card and format it as FAT32.
To cancel initialization, press the **F4 (NO)** button.

CAUTION

After initializing an SD card, it is necessary to format it if you want to use it with the DP-03SD again. (See "Formatting SD cards" on page 27).

12 – Exchanging Data with a Computer

You can backup song data on this unit to a computer and restore backed-up song data later. Moreover, you can export track files and master files from a song to a computer and import audio files on the computer to the unit.

Backed-up data can be restored to a different DP-03SD unit than the one that created it. In other words, files can be freely exchanged between DP-03SD units, making it easy to add additional recordings or mix existing recordings in a different location.

NOTE

- *The MTR partitions where song files are stored cannot be directly accessed from a computer.*
- *In this chapter, “computer” refers to a Windows or Macintosh personal computer connected to this unit (see “Supported operating systems” below).*

CAUTION

If you want to remove an SD card from this unit and back-up its data on a computer using a card reader, always turn off the unit’s power before removing the card.

The following types of data can be transferred from this unit to a computer.

Entire songs

You can transfer the data for an entire song from the unit’s BACKUP directory on the FAT partition to a computer. This operation is called “backup.” In addition, data backed-up on a computer can be transferred to the BACKUP directory on the FAT partition, and then restored as song data. This operation is called “restore.”

WAV format tracks

One or more tracks can be converted to WAV files and exported to a computer, and WAV files on a computer can be imported to this unit. These WAV files are stored on the WAVE directory of this unit’s FAT partition.

Stereo master track

A stereo master track made on this unit can be transferred to a computer as a stereo WAV file from the WAVE directory on the FAT partition. Only export is possible.

Supported operating systems

You can connect this unit to computers with the following operating systems.

Windows

Windows XP, Windows Vista, Windows 7 or Windows 8 (including 8.1)

Mac OS X

Mac OS X 10.2 or later

When this unit is connected to a computer, the computer recognizes it as a removable disk. There is no need for a special driver.

NOTE

Data transfer between this unit and a computer occurs at USB 2.0 speed (maximum). Data can still be transferred if the computer connection is USB 1.1, but it will be slower.

In addition, to assure USB 2.0 speed, use a cable that meets USB 2.0 standards.

Connecting with a computer

To use the FAT partition of this unit, the unit must be connected to a computer by USB. When connected by USB, this unit’s record, playback and other recorder operations cannot be used.

To connect with a computer, connect the USB port on the left side panel of the unit with a USB port on the computer using a mini-B-type USB 2.0 cable. It does not matter whether you turn the unit’s power ON before or after the USB connection is made.

If the USB connection is made while the unit’s power is ON, the currently loaded song is saved before the USB connection becomes effective. When connected, the following screen appears on the display.

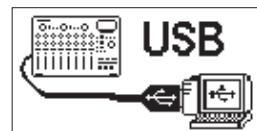

If you turn the unit’s power ON after making the USB connection, the screen above appears right away.

The unit appears as an external drive named DP-03 on the computer’s display.

The FAT partition of the TASCAM DP-03SD has three directories (folders): BACKUP, WAVE and UTILITY.

CAUTION

- *This unit can receive power from the AC adaptor. It cannot be powered by a USB connection.*
- *Do not change the names of three directories (folder) in DP-03.*
- *The total number of files and folders that this unit can recognize on a FAT partition is 100. If the number exceeds 100, use a computer or other device to move them.*
- *Do not disconnect the AC adaptor or otherwise cut the power to the unit during data transfer. Doing so will cause all the data to be lost. This lost data cannot be restored.*

NOTE

- *Confirm that you have copied all the files that you want to transfer to a computer to the FAT partition before connecting the unit and the computer by USB.*
- *The UTILITY directory is used to, for example, update the system software used by the unit.*

Disconnecting

Use the following procedures to disconnect the USB connection correctly.

NOTE

When disconnecting from a computer, the procedure on the computer might be called “eject”, “unmount” or “remove.”

CAUTION

When transferring data, do not disconnect the unit or remove the USB cable. Doing so could cause data on the computer or this unit to be damaged.

12 – Exchanging Data with a Computer

Disconnecting from Windows XP/Windows Vista/Windows 7/Windows 8

Follow the procedures below to disconnect computers that use Windows XP, Windows Vista, Windows 7 or Windows 8 operating systems.

A PC card icon and arrow appear in the taskbar (usually at the bottom right of the screen).



- 1 Left-click on this icon to open a pop-up bar. Click this pop-up bar to disconnect this unit from the computer.
- 2 After a message appears on the computer screen saying that this unit can be disconnected, remove the USB cable. This unit restarts and the Home Screen appears on the display.

If a message appears on the computer screen saying that this unit cannot be disconnected safely, do not disconnect the USB cable. Close all the computer programs and windows that are accessing files on this unit, and then try the operation again.

Disconnecting from Macintosh systems

- 1 Drag the DP-03 icon that represents this unit to the Trash, or type Command-E to eject the DP-03.

TIP

Depending on the OS version or OS settings you might also be able to eject the DP-03 icon by clicking an eject button next to it in the Finder window or by using a control button.

- 2 After the icon disappears from the desktop, remove the USB cable. This unit restarts and the Home Screen appears on the display.

Song backup and restoration

Song backup saves not only audio tracks, but also backs up editing data and other song data. Song restoration is the reverse of this process. In short, song data is transferred from the computer to the FAT partition of the unit and then used to restore the song.

Backing-up songs

- 1 When the recorder is stopped, press the **MENU** button to open the MENU screen.
2. Turn the **DATA** wheel to select **DATA BACKUP**. Press the **F4 (▶)** button to open the **DATA BACKUP** menu.

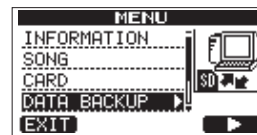

- 3 Use the **DATA** wheel to select **SONG BACKUP**, and press the **F4 (▶)** button to open a song list.

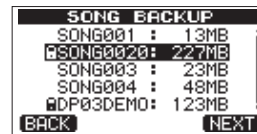

- 4 Turn the **DATA** wheel to select the song that you want to backup, and press the **F4 (NEXT)** button. A screen appears that allows you to set the file name for the song being backed up.



- 5 Use the **REW (◀◀)**/**F FWD (▶▶)** buttons, the **DATA** wheel and the **F3 (INS)** and **F4 (DEL)** buttons, to name the song (maximum of 8 characters) (see "Editing names" on page 30).

12 – Exchanging Data with a Computer

- After setting the name, press the **F2 (EXEC)** button.
A backup copy of the song on the active partition is made on the FAT partition (.001 is added as an extension).

Writing File appears on the display.

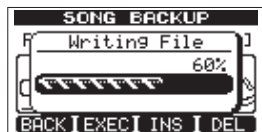

When the backup is complete, the **DATA BACKUP** menu reopens.

NOTE

If the open space necessary to back-up a songs is not available in the FAT partition, an error message appears. In this case, connect this unit and a computer, and erase unnecessary files on the partition using the computer to make enough open space.

- Connect this unit to a computer using a USB cable (see "Connecting with a computer" on page 60).
- Use the computer to copy backup files from the **BACKUP** directory on the FAT partition of the unit to the computer.
- After copying finishes, disconnect the unit from the computer using the proper procedures and then remove the USB cable (see "Disconnecting" on page 60).

CAUTION

- If you use a computer to change the name of a song file that has been backed up, use no more than eight ordinary single-byte English letters and numbers.
- Do not change the file extension.

Restoring songs

Basically, restoring is the reverse of backing up. In short, transfer a backup file on a computer to this unit to restore a song.

- Connect this unit to a computer using a USB cable (see "Connecting with a computer" on page 60).
- Use the computer to copy backup files from the computer to the **BACKUP** directory on the FAT partition of the unit.
- When copying finishes, disconnect the unit from the computer using the proper procedures and then remove the USB cable (see "Disconnecting" on page 60).
- After this unit restarts automatically, press **MENU** to open the **MENU** screen.

- Turn the **DATA** wheel to select **DATA BACKUP** and press the **F4 (▶)** button.

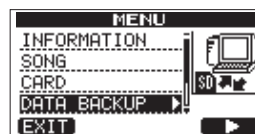

DATA BACKUP screen appears.

- Turn the **DATA** wheel to select **SONG RESTORE**, and press the **F4 (▶)** button.



The screen shows the backup files on the FAT partition.

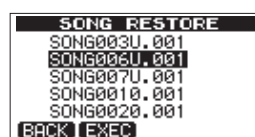

NOTE

An error message appears if there are no files on the FAT partition.

- Turn the **DATA** wheel to select the file that you want to restore, and press the **F2 (EXEC)** button.
The actual song name and a confirmation message (Are you sure?) appear.



NOTE

If the file name is short, spaces appear after the file name on the FAT partition, but those spaces are not included in the actual file name.

- Press the **F3 (YES)** button.
After the currently loaded song is saved, the song selected in step 6 is restored and loaded.

NOTE

If the open space on the card is insufficient, an error message appears.

- Press the **HOME** button to return to the Home Screen.

12 – Exchanging Data with a Computer

Track import and export

You can import and export individual tracks between a computer and this unit's FAT partition. Files that can be imported/exported as tracks must be WAV files (with the ".WAV" extension). You can import both mono and stereo files and export mono files. If you want to import audio into this unit that is of a different format, you must convert it to a 16-bit, 44.1-kHz mono/stereo WAV file first.

Importing tracks

- 1 Connect this unit to a computer using a USB cable (see "Connecting with a computer" on page 60).
- 2 Use the computer to copy WAV files on its drive to the WAVE directory in this unit's FAT partition.
- 3 Disconnect the unit from the computer using the proper procedures and then remove the USB cable (see "Disconnecting" on page 60).
- 4 After this unit restarts automatically, press the **MENU** button to open the MENU screen.
- 5 Turn the **DATA** wheel to select **IMPORT/EXPORT**, and press the **F4 (▶)** button to open the **IMPORT/EXPORT** menu.

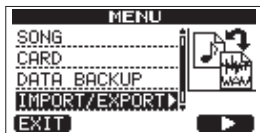

- 6 Turn the **DATA** wheel to select **IMPORT TRACK**, and press the **F4 (▶)** button.



WAV files on the FAT partition are shown.



NOTE

- This unit cannot use WAV files that are a sampling frequency other than 44.1 kHz. Such files are not displayed even if they have been imported.
If no files that can be imported are on the FAT partition, a pop-up saying **Import File Not Found** appears.
- If the file name is short, spaces appear after the file name on the FAT partition, but those spaces are not included in the actual file name.

- 7 Turn the **DATA** wheel to select the WAV file that you want to import, and press the **F2 (NEXT)** button.
The amount of open space on the MTR partition and the size of the selected WAV file appear on the display.



- 8 Turn the **DATA** wheel to select the track that you want to import the WAV file to, and press the **F4 (EXEC)** button.
Importing begins.

NOTE

- If there is not enough open space or the file format is wrong, an error message appears.
 - The track that is the destination for the import must be empty.
This unit reads the file from the FAT partition, and imports it to the designated track. The beginning of the file is set at the start of the song (00:00:00:00).
In the same way as other recording tracks, you can edit the track that has received the imported file (see "8 – Editing Tracks" on page 44).
 - To import a stereo WAV file, an empty track pair is necessary.
- 9 After importing completes, press **HOME** to return to the Home Screen.

12 – Exchanging Data with a Computer

Exporting tracks

You can export tracks as 16-bit, 44.1-kHz mono WAV files.

- 1 When the recorder is stopped, press the **MENU** button to open the MENU screen.
- 2 Turn the **DATA** wheel to select **IMPORT/EXPORT**, and press the **F4 (▶)** button to open the **IMPORT/EXPORT** menu.

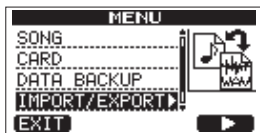

- 3 Turn the **DATA** wheel to select the **EXPORT TRACK** item, and press the **F4 (▶)** button.



Song tracks that have audio recordings are displayed in a list. The file name makes the source track number clear.



TIP

Press **F3 (NAME)** to change the file name.



NOTE

Song tracks that do not have audio recordings are not displayed in the file list.

- 4 Turn the **DATA** wheel, to select a track for export, and press the **F4 (✓)** button to put a check in the checkbox.



By checking multiple checkboxes, you can export more than one track at once. Select a track and press the **F4 (✓)** button again to remove the check from its checkbox.

- 5 When you finish putting checks next to the tracks that you want to export, press the **F2 (NEXT)** button. The amount of open space on the FAT partition (which is the destination for the exported tracks) and the total number of tracks to be exported is shown.



- 6 Press the **F4 (EXEC)** button. The selected track is exported to the FAT partition with the edited file name with the “.WAV” extension added as the track file name. If you have previously exported a track file with the same name, a confirmation message (**Duplicate name - Are you sure?**) appears. Press the **F3 (YES)** button to overwrite the older track.



- 7 Press the **HOME** button to return to the Home Screen.
- 8 Connect this unit to a computer (see “Connecting with a computer” on page 60).
- 9 Use the computer to copy track files from the **WAVE** directory on the FAT partition to the computer.
- 10 After exporting track files to the computer, disconnect the unit from the computer using the proper procedures and then remove the USB cable (see “Disconnecting” on page 60).

12 – Exchanging Data with a Computer

Exporting a stereo master track

You can export a stereo master track that you have made on the unit (see “Creating a stereo master track” on page 49) to a computer. When you create a new stereo master track for a song, the existing stereo master track is overwritten, so if you want to keep multiple different stereo master tracks, you might want to save them to a computer.

Before starting the following export procedures, make sure that the song that you want to export a stereo master track for is currently loaded and that you have already created a stereo master track for it.

- 1 When the recorder is stopped, press the **MENU** button to open the **MENU** screen.
- 2 Turn the **DATA** wheel to select **IMPORT/EXPORT**, and press the **F4** (▶) button to open the **IMPORT/EXPORT** menu.

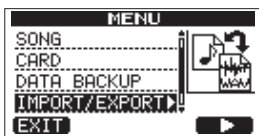

- 3 Turn the **DATA** wheel to select **EXPORT MASTER**, and press the **F4** (▶) button.



The default file name is displayed and can be edited.



NOTE

If there is no stereo master track, an error message appears.

- 4 Use the **REW** (◀◀)/**F FWD** (▶▶) buttons, the **DATA** wheel and the **F3** (**INS**) and **F4** (**DEL**) buttons to edit the name of the stereo master file being exported (See “Editing names” on page 30).

- 5 After setting the name, press the **F2** (**EXEC**) button. A stereo master track file is exported as a 16-bit, 44.1-kHz, stereo WAV file to the FAT partition. The file name of the exported file is the name set in step 4 above plus the “.WAV” extension.

If you have previously exported a stereo master track with the same name, a confirmation message (**Duplicate name – Are you sure?**) appears.



Press the **F3** (**YES**) button to overwrite the older track.

If you don't want to overwrite the older track, press **F4** (**NO**) button.

NOTE

*To cancel exporting, press the **F1** (**BACK**) button.*

- 6 Press the **HOME** button to return to the Home Screen.
- 7 Connect this unit to a computer using a USB cable (see “Connecting with a computer” on page 60).
- 8 Use the computer to copy the stereo master file from the **WAVE** directory on the FAT partition of the unit to the computer.
- 9 After copying finishes, disconnect the unit from the computer using the proper procedures and then remove the USB cable (see “Disconnecting” on page 60).

13 – Mastering compressor settings list

Library of mastering compressor presets

Multiband compressor

Preset name	Description
Basic CD M.	Good for basic CD mastering
POP	Makes the sound quality more showy, bringing out low frequencies and especially emphasizing high frequencies
POP Rock1	While bringing out the high frequencies, this also increases the impact of mid-range frequencies
POP Rock2	Applies even more compression than the “POP Rock1” setting
Rock1	Brings out a full low end suitable for rock
Rock2	Emphasizes low and high frequencies even more than “Rock1” for a sound that stands out
Classic	Smooth compression suitable for classical music
Dance	Suitable for dance music, this preset emphasizes very high and very low frequencies
R&B Hip Hop	Good for R&B and hip-hop, this puts strong compression on high frequencies and adds punch to low frequencies

Single band compressor

Preset name	Description
Basic Comp	Basic setting for evening out the level
Basic Limit	Basic limiter setting
Hard Comp	Results in fairly deep compression
Hard Limit	Deep limiter setting

If using the compressor causes the sound to become distorted, lower the gain of each band or adjust the mixdown so that the maximum level does not quite cause the overload indicator to light. By doing this, you can achieve a good balance and effectively increase the overall sound level.

Masetring compressor parameters list

Lib	TYPE	Threshold			Ratio			Level			Auto Makeup
		High	Mid	Low	High	Mid	Low	High	Mid	Low	
Basic CD M.	3 Band	-16dB	-11dB	-15dB	3.0:1	3.0:1	3.0:1	+6dB	+5dB	+6dB	—
POP	3 Band	-13dB	-13dB	-11dB	4.0:1	4.0:1	4.0:1	+8dB	+2dB	+6dB	—
POP Rock1	3 Band	-13dB	-13dB	-11dB	4.0:1	4.0:1	4.0:1	+7dB	+2dB	+6dB	—
POP Rock2	3 Band	-15dB	-13dB	-11dB	6.0:1	6.0:1	6.0:1	+7dB	+2dB	+5dB	—
Rock1	3 Band	-17dB	-13dB	-11dB	2.0:1	2.0:1	3.0:1	+4dB	+2dB	+3dB	—
Rock2	3 Band	-17dB	-13dB	-11dB	2.0:1	2.0:1	4.0:1	+8dB	+2dB	+3dB	—
Classic	3 Band	-15dB	-13dB	-15dB	1.5:1	1.5:1	1.5:1	+3dB	+5dB	+3dB	—
Dance	3 Band	-14dB	-13dB	-16dB	4.0:1	1.5:1	4.0:1	+8dB	+2dB	+5dB	—
R&B	3 Band	-20dB	-13dB	-19dB	8.0:1	2.0:1	6.0:1	+11dB	+1dB	+8dB	—
Basic Comp	1 Band	-16dB	-16dB	-16dB	2.0:1	2.0:1	2.0:1	+2dB	+2dB	+2dB	On
Basic Limit	1 Band	-18dB	-18dB	-18dB	16:1	16:1	16:1	+2dB	+2dB	+2dB	On
Hard Comp	1 Band	-24dB	-24dB	-24dB	2.5:1	2.5:1	2.5:1	+2dB	+2dB	+2dB	On
Hard Limit	1 Band	-24dB	-24dB	-24dB	16:1	16:1	16:1	+1dB	+1dB	+1dB	On

If you are having trouble with the operation of this unit, please try the following before seeking repair.

If these measures do not solve the problem, please contact the store where you purchased this unit or TASCAM customer support service.

Also, see the “15 – Messages” on page 68 for the meaning of messages that may pop up on the display. Consult this table when a message appears when an operation cannot be completed by the unit.

Why can't I hear any sound when I play back?

- Are the track faders of the tracks set to high enough?
- Is the **MASTER** fader set to high enough?
- Have you connected the **PHONES** or **LINE OUT** jack to your monitoring system properly, and is your monitoring system set up correctly?
- Is the **PHONES LEVEL** knob set to high enough?

Why does the sound I'm recording distorted?

- Are the **TRIM** knobs of the **INPUT A** or **INPUT B** on the top panel of the unit set too high? Is the input source too loud?
- Isn't the monitor system distorted as the monitor level is too high?

Why can't I record?

- You must have at least one track armed (**REC** indicator blinking) before you start recording by pressing the **PLAY (▶)** button while pressing the **RECORD (●)** button.
- Are input channels assigned to tracks (see “Assigning inputs” on page 34)?

Why can't my computer “see” the unit files?

- Is the unit connected to the computer via the USB terminal (see “Connecting with a computer” on page 60)?
- Before making the USB connection, songs, tracks, or stereo master tracks are backed up or exported to the FAT partition? (Files on the MTR partition cannot directly be read.)

Noise occurs if I connect a passive guitar or bass directly.

- Connecting another device to the unit's line output (**LINE OUT**) jacks might reduce the noise.
- This might be caused by interference noise from another device. If there is a power amplifier or other device that uses a large transformer, a fluorescent light or something similar nearby, you might be able to reduce the noise by changing the distance and orientation of this unit in relation to such equipment.
- You might also be able to reduce the noise if you use this unit's **GROUND** connector to ground the unit.

The unit turns off.

- This product is compliant with the European ErP standby power regulations. In order to comply with these regulations, the automatic power saving function is set to 30 minutes when the unit is shipped from the factory. So, by default, the unit will turn off automatically after 30 minutes elapse without any operation. Change the automatic power saving function setting if you want to disable it. (See “Automatic power saving function” on page 56.)

15 – Messages

General messages

The following popup messages alert you to conditions that may arise while you are using the unit. Consult this table if you see something you do not understand.

Messages	Meaning and remedy
Card Full	The SD card is full during recording.
Empty Export Track	You tried to export a track that does not contain any recording data. This pop-up appears if you try to export a song track that does not contain any recording. (See "Track import and export" on page 63.) Export a song track that has been recorded.
File Not Found	You are trying to restore a song when there are no backed-up songs on the FAT partition (See "Song backup and restoration" on page 61).
I/O Too Short	You are trying to enter repeat mode, but the time between the IN and OUT points is too short. Make the time longer (more than 4 seconds). (See "Using IN, OUT and TO points" on page 41.)
Import File Not Found	You are trying to import a WAV file from the FAT partition when there are no WAV files there (See "Importing tracks" on page 63). Connect the unit to a PC and transfer some files to the FAT partition for import.
Import File Too Large	You are trying to import a WAV file from the FAT partition that is too large for the remaining space on the partition. Free up some space on the MTR partition and try again.
In Bounce Mode	You tried to perform an action that cannot be done while in Bounce mode.
In Master Mode	You tried to perform an action that cannot be done while in Master mode.
In Punch Mode	You tried to use a function that is prohibited during punch in/out mode.
In Repeat Mode	You tried to perform an action that cannot be done while in Repeat mode.
Invalid Card	Insert another SD card after turning off the unit, or format the card by MENU → CARD → FORMAT .
Mark Full	You tried to store more than 999 location marks in a song (See "Location marks" on page 40). Delete some location marks and try again.
Master Track Not Found	You have tried to export a stereo master track ("Exporting a stereo master track" on page 65) when the song does not have one. Master the song and then export the stereo master track.
Master Track Too Large	You tried to export a stereo master track which was too large for the remaining space on the FAT partition (See "Exporting a stereo master track" on page 65). Connect the unit to a computer and free up some space on the FAT partition or reformat the FAT partition.
No Armed Track	You tried to enter auto punch in/out mode when no tracks were in record standby. (See "Automatically punching in and out" on page 43.) Put a track into record standby before enabling auto punch in/out mode
No Disk Space	This pop-up message appears when the MTR partition does not contain enough open space when you are trying to create or copy a song. Erase an unwanted song (see "Erasing songs" on page 31), format the card (see "Formatting cards" on page 57) or take other steps to make space available on a card.
No Locate Mark	You're trying to edit the location mark list (see "To edit a location mark" on page 40) when no location marks have been set.
No Master Trk	You have tried to use a non-existent master track as the source in a track cloning operation (see "CLONE track (track duplication)" on page 47). Select another source or master the song and try again.
No SD Card	Insert an SD card after turning off the unit.
No Undo History	There are no actions to be undone. (See "Erasing the operation history" on page 37.)
Not Stopped	The recorder is moving (not stopped, but playing back, recording, etc.) and you have pressed a button such as the UN/REDO [HISTORY] button which cannot be used until you press STOP .
Now Recording	You are trying to perform an action which cannot be done while recording.
Protected Card	To record or edit, turn off the unit and un-protect the SD card.
Same Track	You cannot clone a track to itself. (See "CLONE track (track duplication)" on page 47.)
SD Size Error	Use an SD card larger than 512 MB.
Song Protected	The song is protected ("Protecting songs" on page 32) and you are trying to change it (record or edit, etc.). Unprotect the song.
Too Many songs	You have 250 songs on one partition. You must delete some before you can create another song.

Messages	Meaning and remedy
Track Full	This message appears if you try to import a file when all tracks already have recordings. (See “Importing tracks” on page 63.)
Trk Edit Fail	Save the song and turn the unit off and then on, and perform track edit again.
Trk Too Short	You are trying to enter mixdown mode but the time between the IN and OUT points is too short. Make the time longer (more than 4 seconds). (See “Using IN, OUT and TO points” on page 41.)
Work Memory Full	Even if the card has enough remaining memory space, this error may occur when you record a long song or edit a lot. You may be able to continue the work if you clear the history (See “Erasing the operation history” on page 37.) which may increase the open work memory. You may also be able to continue work by turning the unit off and then on again, which may increase the open work memory.
Audio Rst Fail	If any of these errors occur, turn the unit power OFF and restart it. If the error message continues to appear frequently, please contact the store where you purchased this unit or a TASCAM customer support service.
Device Error	
FileErr	
FX Busy	
FX Rx Failed	
I/F Error	
Mount Error	
SaveParam Fail	
SD-Card Error!	
SD Not Found	
SD Read Busy	
SD Write Busy	

16 – Specifications

Ratings

Recording media

SD card (512 MB - 2 GB) or SDHC card (4 GB - 32 GB)

File system

MTR partition: TASCAM original

FAT partition: FAT32

Built-in mic

Omni directional, 2 pcs

Audio input/output ratings

■ INPUT A jack

XLR type (Balanced)

Connector: XLR-3-31

(1: GND, 2: HOT, 3: COLD)

Input impedance: 2.4 k Ω

Standard input level: -16 dBu

Maximum input level: 0 dBu

1/4" phone jack type (Balanced)

Connector: 6.3 mm (1/4") TRS phone jack

(Tip: HOT, Ring: COLD, Sleeve: GND)

When **INPUT A** switch is set to **MIC/LINE**:

Input impedance: 10 k Ω or more

Standard input level: +4 dBu

Maximum input level: +24 dBu

Headroom: 20 dB

When **INPUT A** switch is set to **GUITAR**:

Input impedance: 1 M Ω

Standard input level: -2 dBV

Maximum input level: +14 dBV

Headroom: 16 dB

■ INPUT B jack

XLR type (Balanced)

Connector: XLR-3-31

(1: GND, 2: HOT, 3: COLD)

Input impedance: 2.4 k Ω

Standard input level: -16 dBu

Maximum input level: 0 dBu

1/4" phone jack type (Balanced)

Connector: 6.3 mm (1/4") TRS phone jack

(Tip: HOT, Ring: COLD, Sleeve: GND)

Input impedance: 10 k Ω or more

Standard input level: +4 dBu

Maximum input level: +24 dBu

Headroom: 20 dB

■ LINE OUT jack

Connector: RCA pin jack

Standard output level: -10 dBV

Maximum output level: +6 dBV

■ PHONES jack

Connector: 3.5 mm stereo mini jack

Maximum output level: 40 mW + 40 mW or more (THD + N 0.1% or less, 32 Ω load)

Control input/output ratings

USB jack

Connector: Mini-B type

Format: USB 2.0 HIGH SPEED, mass storage class

REMOTE jack

Connector: 2.5 mm TS jack

Audio performance

Frequency response

INPUT (MIC/LINE) → LINE OUT: 20 Hz to 20 kHz, +1 dB/-3 dB

Distortion

INPUT (MIC/LINE) → LINE OUT: 0.01% or less

S/N ratio

INPUT (MIC/LINE) → LINE OUT: 90 dB or more

Computer requirements

See the TASCAM website for updated information about OS compatibility.

Windows

Pentium 300 MHz or faster

128 MB or more memory

USB port (USB 2.0 recommended)

Macintosh

Power PC, iMac, G3, G4 266 MHz or faster

64 MB or more memory

USB port (USB 2.0 recommended)

Recommended USB host controller

Intel chipset

Supported OS

Windows XP, Windows Vista, Windows 7 or Windows 8 (including 8.1)

Macintosh Mac OS X 10.2 or later

General

Power supply

TASCAM PS-1225L AC adaptor (included)

AC input: 100-240 V, 1.0 A

DC output: +12 V, 2.5 A

Power consumption

5 W

Dimensions (WHD)

290 x 54.1 x 207.2 mm/

11.42 x 2.13 x 8.16 in

(w/o projections)

Weight

1.4 kg/3.1 lb (w/o AC adaptor)

Operating temperature range

5 - 35°C/41 - 95°F

Backup memory

The following settings are backed up even when the unit power is turned off.

PREFERENCE item

- Repeat Int
- Contrast
- Foot switch L/C/R

Dimensional drawings

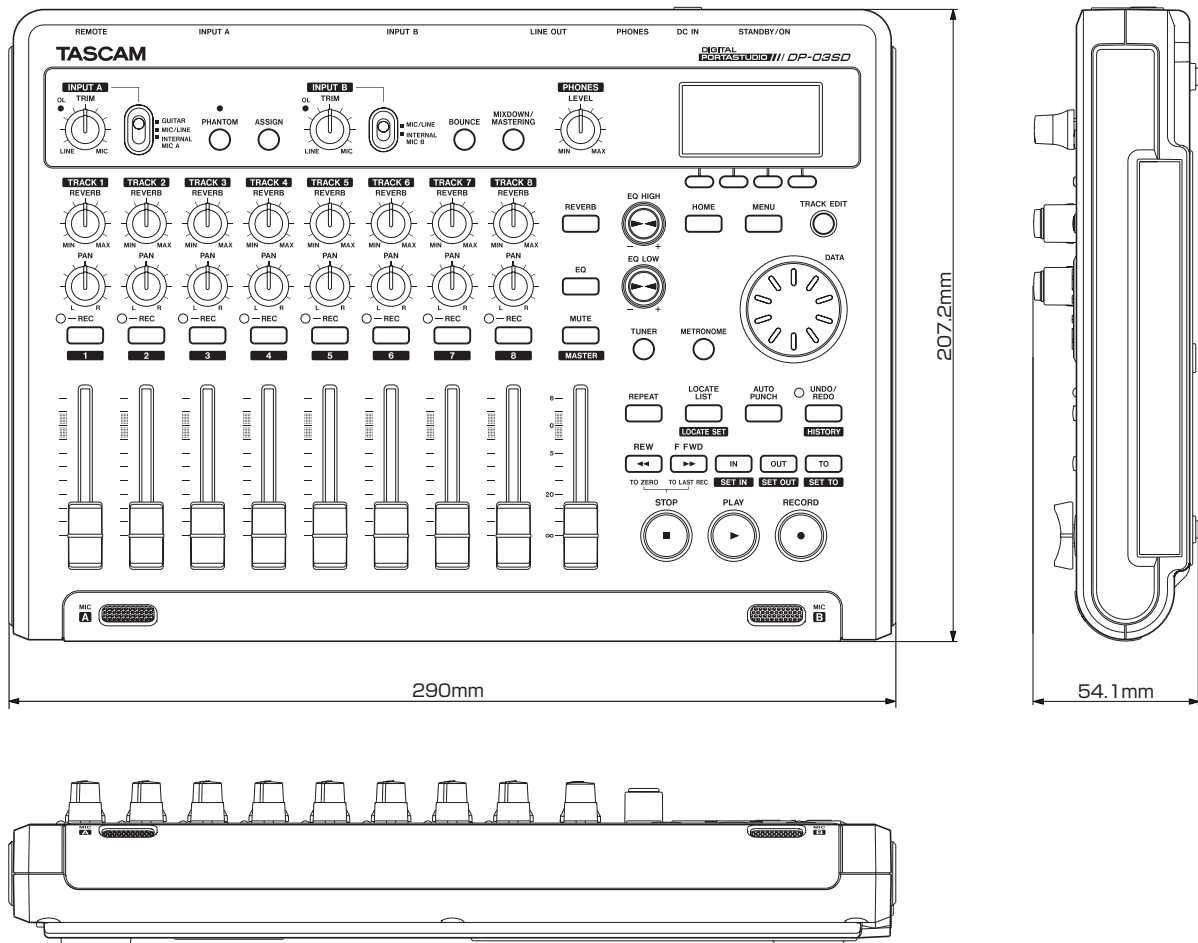

- Illustrations in this manual might differ from the actual product.
- In order to improve the product, specifications and appearance could be changed without prior notice.

16 – Specifications

Block diagram

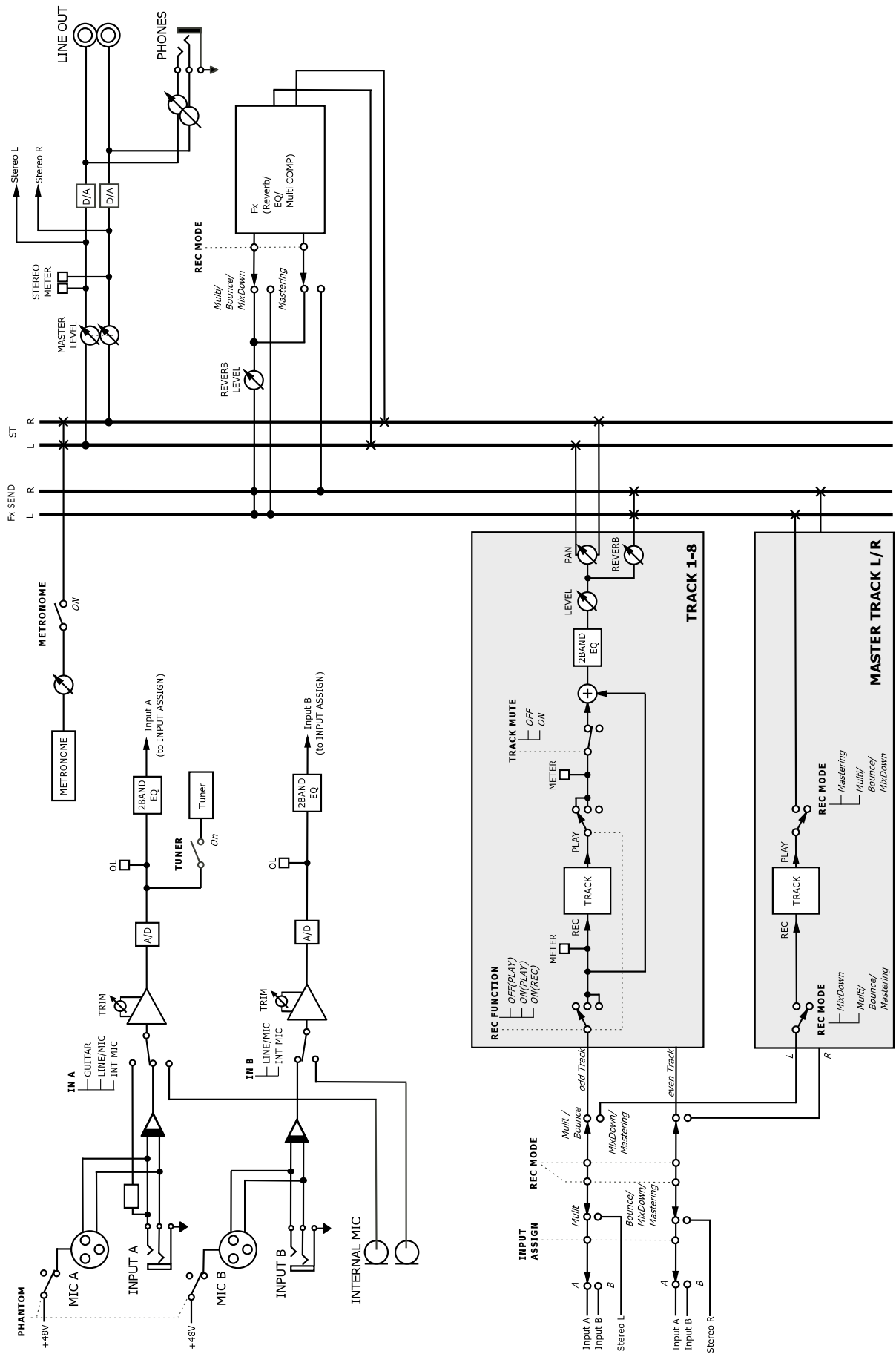

17 – Commonly-used Functions

This section is a brief guide to some operations on the DP-03SD which may not be immediately obvious from looking at the panel controls.

Button sequences are written like this: **STOP** + ◀◀ means “press and hold the **STOP** button and press ◀◀.”

Menu items are written like this: **MENU** → **CARD** → **FORMAT**, meaning “press the **MENU** button, select the **CARD** menu, and then the **FORMAT** action.

The list of popup messages and their meaning (“15 – Messages” on page 68) may also be useful to you.

How to	Buttons, etc. to press	Description
Add reverb	REVERB	See “Reverb” on page 48.
Adjust the gain and frequency of EQ (equalizer)	EQ	See “Using input EQ (equalizer)” on page 34. See “Track EQ (equalizer)” on page 48.
Back up a song to a PC	MENU → DATA BACKUP → SONG BACKUP	See “Backing-up songs” on page 61.
Bounce tracks	BOUNCE	See “Bouncing tracks” on page 39.
Change the interval time during repeat	MENU → PREFERENCE	See “Setting the interval between repetitions” on page 42.
Change the screen contrast	MENU → PREFERENCE	See “Adjusting the contrast” on page 29.
Change the track to which INPUT A/B is assigned	ASSIGN	See “Assigning inputs” on page 34.
Copy a song	MENU → SONG → COPY	See “Copying songs” on page 31.
Create a new song	MENU → SONG → CREATE	See “Creating a new song” on page 30.
Create a stereo master track	MIXDOWN/MASTERING	See “Creating a stereo master track” on page 49.
Cut and close up part a track	TRACK EDIT → CUT	See “CUT (remove part)” on page 47.
Delete a location mark	LOCATE LIST → select the mark with DATA wheel → F2 (EDIT) → F2 (DEL)	See “Location marks” on page 40.
Delete a song	MENU → SONG → ERASE	See “Erasing songs” on page 31.
Delete the whole of a track	TRACK EDIT → CLEAN OUT	See “CLEAN out (track erase)” on page 47.
Display the song name	MENU → INFORMATION	See “Viewing information” on page 56.
Edit the IN and OUT and TO points	LOCATE LIST → F3 (F3 is not necessary if no marks have been added yet)	See “Using IN, OUT and TO points” on page 41.
Edit the location marks	LOCATE LIST → select the mark with DATA wheel → F2 (EDIT)	See “Location marks” on page 40.
Export a stereo master track to a PC	MENU → IMPORT/EXPORT → EXPORT MASTER	See “Exporting a stereo master track” on page 65.
Export a track’s contents to PC	MENU → IMPORT/EXPORT → EXPORT TRACK	See “Exporting tracks” on page 64.
Find out how much time is left for recording	MENU → INFORMATION	See “Viewing song information” on page 31.
Format an SD card	MENU → CARD → FORMAT	See “Formatting cards” on page 57.
Format the FAT partition	MENU → CARD → FAT REFORMAT	See “Reformatting the FAT partition” on page 58.
Format the MTR partition	MENU → CARD → REFORMAT	See “Reformatting MTR partitions” on page 58.
Import a WAV file to a track (from the FAT partition)	MENU → IMPORT/EXPORT → IMPORT TRACK	See “Importing tracks” on page 63.
Insert silence at a point in a track	TRACK EDIT → OPEN	See “OPEN (insert silence)” on page 46.
Jump to a location mark	LOCATE LIST → select the mark with DATA wheel → F4 (JUMP)	See “Location marks” on page 40.
Jump to the IN and OUT and TO points	Press IN , OUT or TO	See “Using IN, OUT and TO points” on page 41.
Load a song	MENU → SONG → LOAD	See “Loading a saved song” on page 30.
Make all of an SD card usable by a PC	MENU → CARD → SD INITIALIZE	See “Initializing SD cards” on page 59.”
Make an exact copy of (clone) a track	TRACK EDIT → CLONE TRACK	See “CLONE track (track duplication)” on page 47.
Metronome settings	METRONOME	See “Metronome” on page 54.
Mute the playback sound of the track	MUTE	See “Muting tracks” on page 49.
Name a song	MENU → SONG → NAME EDIT	See “Editing names” on page 30.

17 – Commonly-used Functions

How to	Buttons, etc. to press	Description
Normalize the volume of the stereo master track	MIXDOWN/MASTERING x2 → F3	See “Mastering the stereo master track” on page 51.
Ping-pong (bounce) to other tracks	BOUNCE	See “Bouncing tracks” on page 39.
Playback a created stereo master track	MIXDOWN/MASTERING x 2	See “Checking the stereo master track” on page 51.
Protect a song	MENU → SONG → PROTECT	See “Protecting songs” on page 32.
Record a guitar	Set the INPUT A switch to GUITAR	See “Selecting the input sources” on page 33.
Redo one operation	UNDO/REDO	See “Undoing an operation” on page 36.
Remove a section of a track and replace it with silence	TRACK EDIT → SILENCE	See “SILENCE (part erase)” on page 47.
Remove the USB connection	Disconnect the unit from a PC	See “Disconnecting” on page 60.
Restore a song from a PC	MENU → DATA BACKUP → SONG RESTORE	See “Restoring songs” on page 62.
Save a song	MENU → SONG → SAVE	See “Saving a song” on page 30.
Set a location mark	Press and hold LOCATE LIST	See “Location marks” on page 40.
Set the IN and OUT points	Press and hold IN , OUT or TO	See “Using IN, OUT and TO points” on page 41.
Tune a guitar or wind instrument	TUNER	See “Tuner” on page 54.
Undo one operation	UNDO/REDO	See “Undoing an operation” on page 36.
Un-protect a song	MENU → SONG → PROTECT	See “Protecting songs” on page 32.
Use EQ (equalizer) on a track	EQ	See “Track EQ (equalizer)” on page 48.
Use EQ (equalizer) on an input signal	EQ	See “Using input EQ (equalizer)” on page 34.
Use equalization on the stereo master track	MIXDOWN/MASTERING x2 → F1	See “Mastering the stereo master track” on page 51.
Use phantom power	PHANTOM	See “Using phantom power” on page 33.
Use the built-in mic	Set the INPUT A/B switch to INTERNAL MIC A/B	See “Selecting the input sources” on page 33.
Use the metronome	METRONOME	See “Metronome” on page 54.
Use the USB connection	Connect the unit and a PC with the USB cable.	See “Connecting with a computer” on page 60.
User compression on the stereo master track	MIXDOWN/MASTERING x2 → F2	See “Mastering the stereo master track” on page 51.

WARRANTY

< In the United States >

This warranty gives you specific legal rights and you may also have other rights which vary from state to state. This warranty is only valid within the country the unit was originally purchased.

WHAT IS AND IS NOT COVERED

Except as specified below, this warranty covers all defects in materials and workmanship in this product. The following are not covered by the warranty:

1. **Damage to or deterioration of the external cabinet.**
2. **Damages resulting from accident, misuse, abuse or neglect.**
3. **Damage resulting from failure to perform basic daily maintenance and/or calibration or otherwise resulting from failure to follow instructions contained in your owner's manual.**
4. **Damage occurring during shipment of the product. (Claims must be presented to the carrier)**
5. **Damage resulting from repair or attempted repair by anyone other than TEAC or an authorized TASCAM service station.**
6. **Damage resulting from causes other than product defects, including lack of technical skill, competence, or experience of the user.**
7. **Damage to any unit which has been altered or on which the serial number has been defaced, modified or is missing.**

WHO MAY ENFORCE THE WARRANTY

This warranty may be enforced only by the original purchaser.

LENGTH OF WARRANTY

All parts except heads and disk drives are warranted for one (1) year from the date of original purchase. Heads and disk drives are warranted to ninety (90) days from date of original purchase. Labor is warranted for ninety (90) days from date of original purchase.

WHAT WE WILL PAY FOR

We will pay all labor and material expenses for items covered by the warranty. Payment of shipping charges is discussed in the next section of this warranty.

HOW YOU CAN GET WARRANTY SERVICE

Your unit must be serviced by an authorized TASCAM service station in the United States. (This warranty is not enforceable outside the U.S.) If you are unable to locate an authorized TASCAM service station in your area, please contact us. We either will refer you to an authorized service station or instruct you to return the unit to the factory. Whenever warranty service is required, you must present a copy of the original dated sales receipt from an Authorized TASCAM Dealer.

You must pay any shipping charges if it is necessary to ship the product to service. However, if the necessary repairs are covered by the warranty, we will pay return surface shipping charges to any destination within the United States.

LIMITATION OF IMPLIED WARRANTIES

Any implied warranties, INCLUDING WARRANTIES OF MERCHANTABILITY AND FITNESS FOR A PARTICULAR PURPOSE, are limited in duration to the length of this warranty.

EXCLUSION OF DAMAGES

TEAC's liability for any defective product is limited to repair or replacement of the product, at TEAC's option. TEAC shall not be liable for:

1. **Damages based upon inconvenience, loss of use of the product, loss of time interrupted operation or commercial loss; or**
2. **Any other damages, whether incidental, consequential or otherwise.**

Some states do not allow limitations on how long an implied warranty lasts and/or do not allow the exclusion or limitation of incidental or consequential damages, so the above limitations and exclusions may not apply to you.

To locate an Authorized Service Center in Your Area

CALL 1-800-447-8322

< Europe >

This product is subject to the legal warranty regulations of the country of purchase. In case of a defect or a problem, please contact the dealer where you bought the product.

Ce produit est sujet aux réglementations concernant la garantie légale dans le pays d'achat. En cas de défaut ou de problème, veuillez contacter le revendeur chez qui vous avez acheté le produit.

Dieses Gerät unterliegt den gesetzlichen Gewährleistungsbestimmungen des Landes, in dem es erworben wurde. Bitte wenden Sie sich im Gewährleistungsfall an den Händler, bei dem sie das Gerät erworben haben.

Questo apparecchio è conforme alle norme sulla garanzia vigenti nel rispettivo Paese in cui esso è stato acquistato. Si prega di rivolgersi al proprio commerciante, presso il quale è stato acquistato l'apparecchio, nel caso in cui si voglia richiedere una prestazione in garanzia.

Las condiciones de garantía de este aparato están sujetas a las disposiciones legales sobre garantía del país en el que ha sido adquirido. En caso de garantía, debe dirigirse al establecimiento donde adquirió el aparato.

< In other countries/areas >

This warranty gives you specific legal rights, and you may also have other rights that vary by country, state or province.

If you have a warranty claim or request, please contact the dealer where you bought the product.

该保证书赋予了顾客特定的合法权利，并且因国家、州或省等地域的不同，顾客可能拥有其他权利。如需申请或要求保修，请与购买本产品的销售店进行联系。

If you require repair services for your TASCAM equipment, please contact the dealer where the product was purchased from or the TASCAM Distributor in your country. A list of TASCAM Distributors can be found on our website at: <http://teac-global.com/>

TASCAM

TEAC CORPORATION

Phone: +81-42-356-9143
1-47 Ochiai, Tama-shi, Tokyo 206-8530 Japan

<https://tascam.jp/jp/>

TEAC AMERICA, INC.

Phone: +1-323-726-0303
10410 Pioneer Blvd. Suite #1 and #4, Santa Fe Springs, California 90670, U.S.A.

<https://tascam.com/us/>

TEAC UK Ltd.

Phone: +44-1923-797205
Meridien House, 69-71 Clarendon Road, Watford, Herts, WD17 1DS, United Kingdom

<https://tascam.eu/>

TEAC EUROPE GmbH

Phone: +49-611-71580
Bahnstrasse 12, 65205 Wiesbaden-Erbenheim, Germany

<https://tascam.de/>

TEAC SALES & TRADING(SHENZHEN) CO., LTD

Phone: +86-755-88311561~2
Room 817, Block A, Hailrun Complex, 6021 Shennan Blvd., Futian District, Shenzhen 518040, China

<http://tascam.cn/>

1118.MA-2763A

Printed in China

WARRANTY

Model/Modèle/Modell
Modello/Modelo/型号

Owner's name/Nom du possesseur/Name des Eigentümers
Nome del proprietario/Nombre del propietario/顾客姓名

DP-03SD

Serial No./No de série/Numero de serie
Numero di serie/Serial No./序列号

Address/Adresse/Adresse
Indirizzo/Dirección/顾客地址

Date of purchase/Date de l'achat/Datum des Kaufs
Data dell'acquisto/Fecha de compra/购买日期

Dealer's name/Nom du détaillant/Name des Händlers
Nome del commerciante/Nombre del establecimiento/销售店名

TASCAM
<http://teac-global.com/>

Dealer's address/Adresse du détaillant/Adresse des Händlers
Indirizzo del commerciante/Dirección del establecimiento/销售店地址